

- Output Swing includes Both Supply Rails
- Low Noise . . . 12 nV/√Hz Typ at f = 1 kHz
- Low Input Bias Current . . . 1 pA Typ
- Fully Specified for Both Single-Supply and Split-Supply Operation
- Low Power . . . 500 μA Max
- Common-Mode Input Voltage Range Includes Negative Rail
- Low Input Offset Voltage
950 μV Max at T_A = 25°C (TLC2262A)
- Macromodel Included
- Performance Upgrade for the TS27M2/M4 and TLC27M2/M4
- Available in Q-Temp Automotive HighRel Automotive Applications Configuration Control / Print Support Qualification to Automotive Standards

description

The TLC2262 and TLC2264 are dual and quadruple operational amplifiers from Texas Instruments. Both devices exhibit rail-to-rail output performance for increased dynamic range in single- or split-supply applications. The TLC226x family offers a compromise between the micropower TLC225x and the ac performance of the TLC227x. It has low supply current for battery-powered applications, while still having adequate ac performance for applications that demand it. The noise performance has been dramatically improved over previous generations of CMOS amplifiers. Figure 1 depicts the low level of noise voltage for this CMOS amplifier, which has only 200 μA (typ) of supply current per amplifier.

The TLC226x, exhibiting high input impedance and low noise, are excellent for small-signal conditioning for high-impedance sources, such as piezoelectric transducers. Because of the micro-power dissipation levels, these devices work well in hand-held monitoring and remote-sensing applications. In addition, the rail-to-rail output feature with single or split supplies makes this family a great choice when interfacing with analog-to-digital converters (ADCs). For precision applications, the TLC226xA family is available and has a maximum input offset voltage of 950 μV. This family is fully characterized at 5 V and ±5 V.

The TLC2262/4 also makes great upgrades to the TLC27M2/L4 or TS27M2/L4 in standard designs. They offer increased output dynamic range, lower noise voltage and lower input offset voltage. This enhanced feature set allows them to be used in a wider range of applications. For applications that require higher output drive and wider input voltage range, see the TLV2432 and TLV2442. If your design requires single amplifiers, please see the TLV2211/21/31 family. These devices are single rail-to-rail operational amplifiers in the SOT-23 package. Their small size and low power consumption, make them ideal for high density, battery-powered equipment.

EQUIVALENT INPUT NOISE VOLTAGE
vs
FREQUENCY

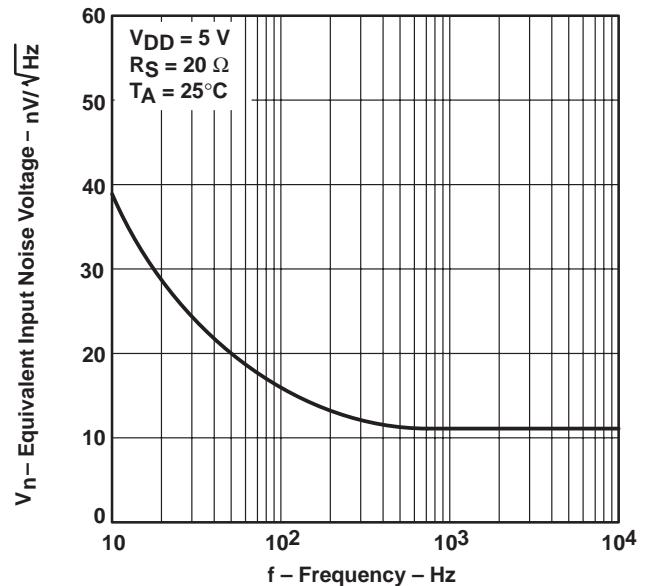

Figure 1



Please be aware that an important notice concerning availability, standard warranty, and use in critical applications of Texas Instruments semiconductor products and disclaimers thereto appears at the end of this data sheet.

Advanced LinCMOS is a trademark of Texas Instruments Incorporated.

PRODUCTION DATA information is current as of publication date. Products conform to specifications per the terms of Texas Instruments standard warranty. Production processing does not necessarily include testing of all parameters.

 **TEXAS
INSTRUMENTS**

POST OFFICE BOX 655303 • DALLAS, TEXAS 75265

Copyright © 1999, Texas Instruments Incorporated
On products compliant to MIL-PRF-38535, all parameters are tested unless otherwise noted. On all other products, production processing does not necessarily include testing of all parameters.

TLC226x, TLC226xA

Advanced LinCMOS™ RAIL-TO-RAIL OPERATIONAL AMPLIFIERS

SLOS177A – FEBRUARY 1997 – REVISED JULY 1999

TLC2262 AVAILABLE OPTIONS

T _A	V _{IO} max AT 25°C	PACKAGED DEVICES					
		SMALL OUTLINE (D)	CHIP CARRIER (FK)	CERAMIC DIP (JG)	PLASTIC DIP (P)	TSSOP (PW)	CERAMIC FLATPACK (U)
0°C to 70°C	2.5 mV	TLC2262CD	—	—	TLC2262CP	TLC2262CPWLE	—
–40°C to 125°C	950 μV 2.5 mV	TLC2262AID TLC2262ID	— —	— —	TLC2262AIP TLC2262IP	TLC2262AIPWLE —	— —
–40°C to 125°C	950 μV 2.5 mV	TLC2262AQD TLC2262QD	— —	— —	— —	— —	— —
–55°C to 125°C	950 μV 2.5 mV	— —	TLC2262AMFK TLC2262MFK	TLC2262AMJG TLC2262MJG	— —	— —	TLC2262AMU TLC2262MU

The D packages are available taped and reeled. Add R suffix to device type (e.g., TLC2262CDR). The PW package is available only left-end taped and reeled. Chips are tested at 25°C.

TLC2264 AVAILABLE OPTIONS

T _A	V _{IO} max AT 25°C	PACKAGED DEVICES					
		SMALL OUTLINE (D)	CHIP CARRIER (FK)	CERAMIC DIP (J)	PLASTIC DIP (N)	TSSOP (PW)	CERAMIC FLATPACK (W)
0°C to 70°C	2.5 mV	TLC2264CD	—	—	TLC2264CN	TLC2264CPWLE	—
–40°C to 125°C	950 μV 2.5 mV	TLC2264AID TLC2264ID	— —	— —	TLC2264AIN TLC2264IN	TLC2264AIPWLE —	— —
–40°C to 125°C	950 μV 2.5 mV	TLC2264AQD TLC2264QD	— —	— —	— —	— —	— —
–55°C to 125°C	950 μV 2.5 mV	— —	TLC2264AMFK TLC2264MFK	TLC2264AMJ TLC2264MJ	— —	— —	TLC2264AMW TLC2264MW

The D packages are available taped and reeled. Add R suffix to device type (e.g., TLC2264CDR). The PW package is available only left-end taped and reeled. Chips are tested at 25°C.

TLC226x, TLC226xA
Advanced LinCMOS™ RAIL-TO-RAIL
OPERATIONAL AMPLIFIERS

SLOS177A – FEBRUARY 1997 – REVISED JULY 1999

TLC2262C, TLC2262AC
TLC2262I, TLC2262AI
TLC2262Q, TLC2262AQ
D, P, OR PW PACKAGE
(TOP VIEW)

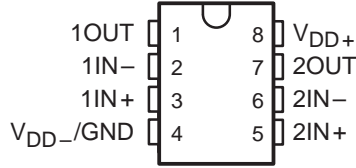

TLC2262M, TLC2262AM . . . FK PACKAGE
(TOP VIEW)

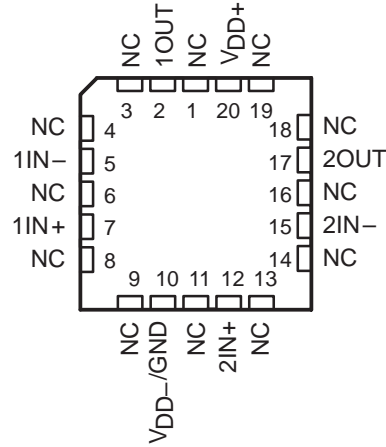

TLC2262M, TLC2262AM . . . JG PACKAGE
(TOP VIEW)

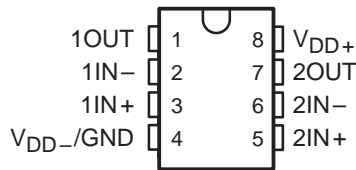

TLC2262M, TLC2262AM . . . U PACKAGE
(TOP VIEW)

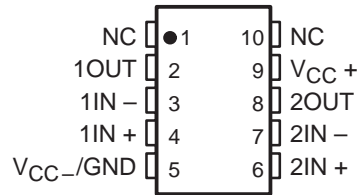

TLC2264C, TLC2264AC
TLC2264I, TLC2264AI
TLC2264Q, TLC2264AQ
D, N, OR PW PACKAGE
(TOP VIEW)

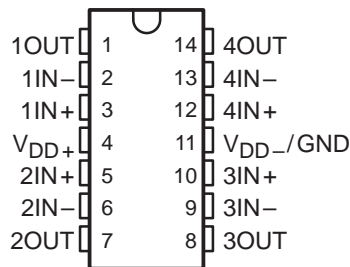

TLC2264M, TLC2264AM . . . J OR W PACKAGE
(TOP VIEW)

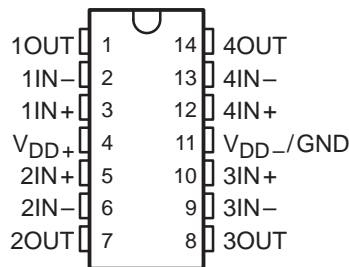

TLC2264M, TLC2264AM . . . FK PACKAGE
(TOP VIEW)

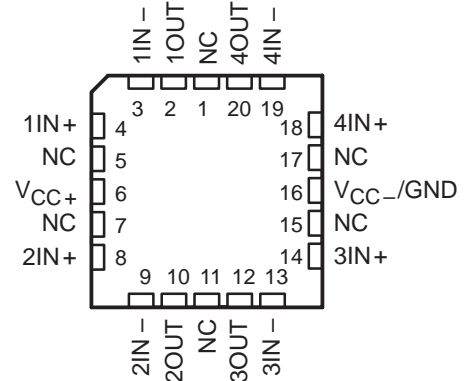

TLC226x, TLC226xA

Advanced LincMOS™ RAIL-TO-RAIL OPERATIONAL AMPLIFIERS

SLOS177A – FEBRUARY 1997 – REVISED JULY 1999

equivalent schematic (each amplifier)

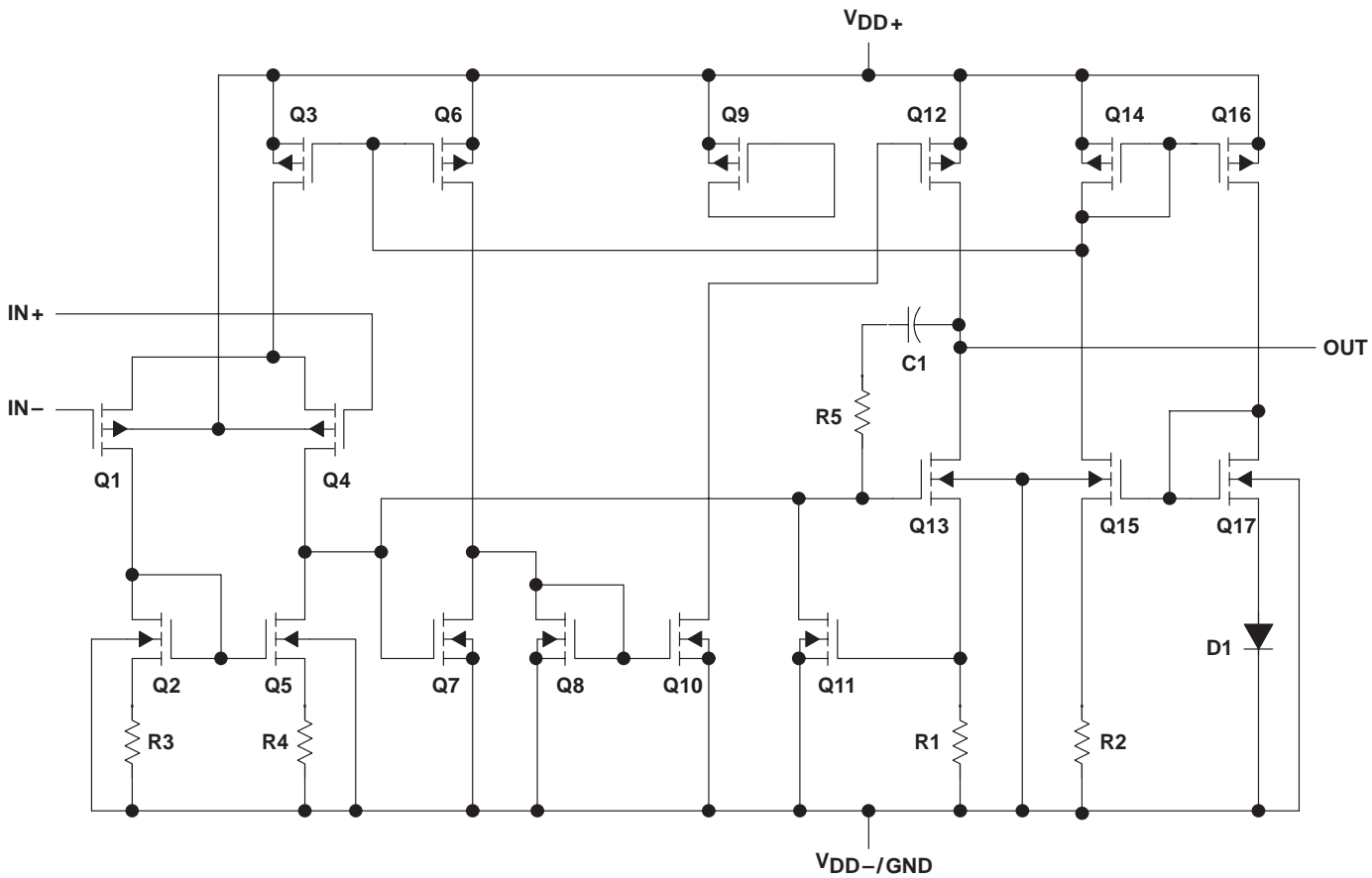

ACTUAL DEVICE COMPONENT COUNT†		
COMPONENT	TLC2262	TLC2264
Transistors	38	76
Resistors	28	56
Diodes	9	18
Capacitors	3	6

† Includes both amplifiers and all ESD, bias, and trim circuitry

absolute maximum ratings over operating free-air temperature range (unless otherwise noted)†

Supply voltage, V_{DD+} (see Note 1)	8 V
Supply voltage, V_{DD-} (see Note 1)	–8 V
Differential input voltage, V_{ID} (see Note 2)	±16 V
Input voltage, V_I (any input, see Note 1)	$V_{DD-} - 0.3\text{ V}$ to V_{DD+}
Input current, I_I (each input)	±5 mA
Output current, I_O	±50 mA
Total current into V_{DD+}	±50 mA
Total current out of V_{DD-}	±50 mA
Duration of short-circuit current at (or below) 25°C (see Note 3)	unlimited
Continuous total dissipation	See Dissipation Rating Table
Operating free-air temperature range, T_A : C suffix	0°C to 70°C
I suffix	–40°C to 125°C
Q suffix	–40°C to 125°C
M suffix	–55°C to 125°C
Storage temperature range, T_{stg}	–65°C to 150°C
Lead temperature 1,6 mm (1/16 inch) from case for 10 seconds: D, N, P, and PW packages	260°C
J, JG, U, and W packages	300°C

† Stresses beyond those listed under “absolute maximum ratings” may cause permanent damage to the device. These are stress ratings only, and functional operation of the device at these or any other conditions beyond those indicated under “recommended operating conditions” is not implied. Exposure to absolute-maximum-rated conditions for extended periods may affect device reliability.

- NOTES: 1. All voltage values, except differential voltages, are with respect to the midpoint between V_{DD+} and V_{DD-} .
2. Differential voltages are at $IN+$ with respect to $IN-$. Excessive current flows if input is brought below $V_{DD-} - 0.3\text{ V}$.
3. The output may be shorted to either supply. Temperature and/or supply voltages must be limited to ensure that the maximum dissipation rating is not exceeded.

DISSIPATION RATING TABLE

PACKAGE	$T_A \leq 25^\circ\text{C}$ POWER RATING	DERATING FACTOR ABOVE $T_A = 25^\circ\text{C}$	$T_A = 70^\circ\text{C}$ POWER RATING	$T_A = 85^\circ\text{C}$ POWER RATING	$T_A = 125^\circ\text{C}$ POWER RATING
D–8	725 mW	5.8 mW/°C	464 mW	377 mW	145 mW
D–14	950 mW	7.6 mW/°C	608 mW	494 mW	190 mW
FK	1375 mW	11.0 mW/°C	880 mW	715 mW	275 mW
J	1375 mW	11.0 mW/°C	880 mW	715 mW	275 mW
JG	1050 mW	8.4 mW/°C	672 mW	546 mW	210 mW
N	1150 mW	9.2 mW/°C	736 mW	598 mW	230 mW
P	1000 mW	8.0 mW/°C	640 mW	520 mW	200 mW
PW–8	525 mW	4.2 mW/°C	336 mW	273 mW	105 mW
PW–14	700 mW	5.6 mW/°C	448 mW	364 mW	140 mW
U	700 mW	5.5 mW/°C	452 mW	370 mW	150 mW
W	700 mW	5.5 mW/°C	452 mW	370 mW	150 mW

recommended operating conditions

	C SUFFIX		I SUFFIX		Q SUFFIX		M SUFFIX		UNIT
	MIN	MAX	MIN	MAX	MIN	MAX	MIN	MAX	
Supply voltage, $V_{DD\pm}$	±2.2	±8	±2.2	±8	±2.2	±8	±2.2	±8	V
Input voltage range, V_I	V_{DD-}	$V_{DD+} - 1.5$	V_{DD-}	$V_{DD+} - 1.5$	V_{DD-}	$V_{DD+} - 1.5$	V_{DD-}	$V_{DD+} - 1.5$	V
Common-mode input voltage, V_{IC}	V_{DD-}	$V_{DD+} - 1.5$	V_{DD-}	$V_{DD+} - 1.5$	V_{DD-}	$V_{DD+} - 1.5$	V_{DD-}	$V_{DD+} - 1.5$	V
Operating free-air temperature, T_A	0	70	–40	125	–40	125	–55	125	°C

TLC226x, TLC226xA

Advanced LinCMOS™ RAIL-TO-RAIL OPERATIONAL AMPLIFIERS

SLOS177A – FEBRUARY 1997 – REVISED JULY 1999

TLC2262C electrical characteristics at specified free-air temperature, $V_{DD} = 5\text{ V}$ (unless otherwise noted)

PARAMETER	TEST CONDITIONS	T_A †	TLC2262C			UNIT
			MIN	TYP	MAX	
V_{IO} Input offset voltage	$V_{IC} = 0,$ $V_O = 0,$ $V_{DD} \pm = \pm 2.5\text{ V},$ $R_S = 50\ \Omega$	25°C	300	2500	μV	
		Full range	3000			
α_{VIO} Temperature coefficient of input offset voltage		25°C to 70°C	2		$\mu\text{V}/^\circ\text{C}$	
Input offset voltage long-term drift (see Note 4)		25°C	0.003		$\mu\text{V}/\text{mo}$	
I_{IO} Input offset current		25°C	0.5		pA	
		Full range	100			
I_{IB} Input bias current	25°C	1		pA		
	Full range	100				
V_{ICR} Common-mode input voltage range	$R_S = 50\ \Omega,$ $ V_{IO} \leq 5\text{ mV}$	25°C	0 to 4	-0.3 to 4.2	V	
		Full range	0 to 3.5			
V_{OH} High-level output voltage	$I_{OH} = -20\ \mu\text{A}$ $I_{OH} = -100\ \mu\text{A}$ $I_{OH} = -400\ \mu\text{A}$	25°C	4.99		V	
		25°C	4.85	4.94		
		Full range	4.82			
		25°C	4.70	4.85		
V_{OL} Low-level output voltage	$V_{IC} = 2.5\text{ V},$ $I_{OL} = 50\ \mu\text{A}$	25°C	0.01		V	
		25°C	0.09	0.15		
	Full range	0.15				
	$V_{IC} = 2.5\text{ V},$ $I_{OL} = 1\text{ mA}$	25°C	0.2	0.3		
		Full range	0.3			
	$V_{IC} = 2.5\text{ V},$ $I_{OL} = 4\text{ mA}$	25°C	0.7	1		
		Full range	1.2			
	A_{VD} Large-signal differential voltage amplification	$V_{IC} = 2.5\text{ V},$ $V_O = 1\text{ V to }4\text{ V}$	$R_L = 50\text{ k}\Omega^\ddagger$	25°C		80
Full range				55		
$R_L = 1\text{ M}\Omega^\ddagger$			25°C	550		
$r_{i(d)}$ Differential input resistance		25°C	10^{12}		Ω	
$r_{i(c)}$ Common-mode input resistance		25°C	10^{12}		Ω	
$c_{i(c)}$ Common-mode input capacitance	$f = 10\text{ kHz},$ P package	25°C	8		pF	
z_o Closed-loop output impedance	$f = 100\text{ kHz},$ $A_V = 10$	25°C	240		Ω	
CMRR Common-mode rejection ratio	$V_{IC} = 0\text{ to }2.7\text{ V},$ $V_O = 2.5\text{ V},$ $R_S = 50\ \Omega$	25°C	70	83	dB	
		Full range	70			
k_{SVR} Supply-voltage rejection ratio ($\Delta V_{DD}/\Delta V_{IO}$)	$V_{DD} = 4.4\text{ V to }16\text{ V},$ $V_{IC} = V_{DD}/2,$ No load	25°C	80	95	dB	
		Full range	80			
I_{DD} Supply current	$V_O = 2.5\text{ V},$ No load	25°C	400	500	μA	
		Full range	500			

† Full range is 0°C to 70°C.

‡ Referenced to 2.5 V

NOTE 4: Typical values are based on the input offset voltage shift observed through 500 hours of operating life test at $T_A = 150^\circ\text{C}$ extrapolated to $T_A = 25^\circ\text{C}$ using the Arrhenius equation and assuming an activation energy of 0.96 eV.



TLC2262C operating characteristics at specified free-air temperature, $V_{DD} = 5\text{ V}$

PARAMETER		TEST CONDITIONS		T_A †	TLC2262C			UNIT
					MIN	TYP	MAX	
SR	Slew rate at unity gain	$V_O = 1.5\text{ V to }3.5\text{ V},$ $C_L = 100\text{ pF}‡$	$R_L = 50\text{ k}\Omega‡,$	25°C	0.35	0.55	V/ μs	
				Full range	0.3			
V_n	Equivalent input noise voltage			25°C	40		nV/ $\sqrt{\text{Hz}}$	
				25°C	12			
$V_{N(PP)}$	Peak-to-peak equivalent input noise voltage			25°C	0.7		μV	
				25°C	1.3			
I_n	Equivalent input noise current			25°C	0.6		fA/ $\sqrt{\text{Hz}}$	
THD + N	Total harmonic distortion plus noise	$V_O = 0.5\text{ V to }2.5\text{ V},$ $f = 20\text{ kHz},$ $R_L = 50\text{ k}\Omega‡$		25°C	$A_V = 1$			
					$A_V = 10$			
Gain-bandwidth product		$f = 10\text{ kHz},$ $C_L = 100\text{ pF}‡$	$R_L = 50\text{ k}\Omega‡,$	25°C	0.71		MHz	
BOM	Maximum output-swing bandwidth	$V_{O(PP)} = 2\text{ V},$ $R_L = 50\text{ k}\Omega‡,$	$A_V = 1,$ $C_L = 100\text{ pF}‡$	25°C	185		kHz	
t_s	Settling time	$A_V = -1,$ Step = 0.5 V to 2.5 V, $R_L = 50\text{ k}\Omega‡,$ $C_L = 100\text{ pF}‡$	To 0.1%	25°C	6.4		μs	
			To 0.01%		14.1			
ϕ_m	Phase margin at unity gain	$R_L = 50\text{ k}\Omega‡,$	$C_L = 100\text{ pF}‡$	25°C	56°			
	Gain margin			25°C	11		dB	

† Full range is 0°C to 70°C.

‡ Referenced to 2.5 V

TLC226x, TLC226xA
Advanced LinCMOS™ RAIL-TO-RAIL
OPERATIONAL AMPLIFIERS

SLOS177A – FEBRUARY 1997 – REVISED JULY 1999

TLC2262C electrical characteristics at specified free-air temperature, $V_{DD\pm} = \pm 5\text{ V}$ (unless otherwise specified)

PARAMETER	TEST CONDITIONS	T _A †	TLC2262C			UNIT
			MIN	TYP	MAX	
V _{IO} Input offset voltage	V _{IC} = 0, V _O = 0, R _S = 50 Ω	25°C		300	2500	μV
		Full range			3000	
αV _{IO} Temperature coefficient of input offset voltage		25°C to 70°C		2		μV/°C
Input offset voltage long-term drift (see Note 4)		25°C		0.003		μV/mo
I _{IO} Input offset current		25°C		0.5		pA
		Full range			100	
I _{IB} Input bias current		25°C		1		pA
		Full range			100	
V _{ICR} Common-mode input voltage range	V _{IO} ≤ 5 mV, R _S = 50 Ω	25°C	-5 to 4	-5.3 to 4.2	V	
		Full range	-5 to 3.5			
V _{OM+} Maximum positive peak output voltage	I _O = -20 μA	25°C		4.99	V	
	I _O = -100 μA	25°C	4.85	4.94		
		Full range	4.82			
	I _O = -400 μA	25°C	4.7	4.85		
Full range		4.6				
V _{OM-} Maximum negative peak output voltage	V _{IC} = 0, I _O = 50 μA	25°C		-4.99	V	
		Full range	-4.85	-4.91		
	V _{IC} = 0, I _O = 500 μA	25°C		-4.85		
		Full range	-4.7	-4.8		
	V _{IC} = 0, I _O = 1 mA	25°C		-4.7		
		Full range	-4.7			
V _{IC} = 0, I _O = 4 mA	25°C		-4	-4.3		
	Full range	-3.8				
A _{VD} Large-signal differential voltage amplification	V _O = ±4 V	R _L = 50 kΩ	25°C	80	200	V/mV
			Full range	55		
		R _L = 1 MΩ	25°C		1000	
r _{i(d)} Differential input resistance		25°C		10 ¹²	Ω	
r _{i(c)} Common-mode input resistance		25°C		10 ¹²	Ω	
c _{i(c)} Common-mode input capacitance	f = 10 kHz, P package	25°C		8	pF	
z _o Closed-loop output impedance	f = 100 kHz, A _V = 10	25°C		220	Ω	
CMRR Common-mode rejection ratio	V _{IC} = -5 V to 2.7 V, V _O = 0 V, R _S = 50 Ω	25°C	75	88	dB	
		Full range	75			
k _{SVR} Supply-voltage rejection ratio (ΔV _{DD±} / ΔV _{IO})	V _{DD±} = 2.2 V to ±8 V, V _{IC} = 0, No load	25°C	80	95	dB	
		Full range	80			
I _{DD} Supply current	V _O = 0 V, No load	25°C	425	500	μA	
		Full range		500		

† Full range is 0°C to 70°C.

NOTE 4: Typical values are based on the input offset voltage shift observed through 500 hours of operating life test at T_A = 150°C extrapolated to T_A = 25°C using the Arrhenius equation and assuming an activation energy of 0.96 eV.



TLC226x, TLC226xA
Advanced LinCMOS™ RAIL-TO-RAIL
OPERATIONAL AMPLIFIERS

SLOS177A – FEBRUARY 1997 – REVISED JULY 1999

TLC2262C operating characteristics at specified free-air temperature, $V_{DD\pm} = \pm 5\text{ V}$

PARAMETER		TEST CONDITIONS		T_A †	TLC2262C			UNIT
					MIN	TYP	MAX	
SR	Slew rate at unity gain	$V_O = \pm 1.9\text{ V}$, $C_L = 100\text{ pF}$	$R_L = 50\text{ k}\Omega$	25°C	0.35	0.55	V/ μs	
				Full range	0.3			
V_n	Equivalent input noise voltage			25°C	43		nV/ $\sqrt{\text{Hz}}$	
				25°C	12			
$V_{N(PP)}$	Peak-to-peak equivalent input noise voltage			25°C	0.8		μV	
				25°C	1.3			
I_n	Equivalent input noise current			25°C	0.6		fA/ $\sqrt{\text{Hz}}$	
THD + N	Total harmonic distortion pulse duration	$V_O = \pm 2.3\text{ V}$, $f = 20\text{ kHz}$, $R_L = 50\text{ k}\Omega$		25°C	$A_V = 1$	0.014%		
					$A_V = 10$	0.024%		
Gain-bandwidth product		$f = 10\text{ kHz}$, $C_L = 100\text{ pF}$	$R_L = 50\text{ k}\Omega$	25°C	0.73		MHz	
BOM	Maximum output-swing bandwidth	$V_{O(PP)} = 4.6\text{ V}$, $R_L = 50\text{ k}\Omega$	$A_V = 1$, $C_L = 100\text{ pF}$	25°C	85		kHz	
t_s	Settling time	$A_V = -1$, Step = -2.3 V to 2.3 V , $R_L = 50\text{ k}\Omega$, $C_L = 100\text{ pF}$		25°C	To 0.1%	7.1		
					To 0.01%	16.5		
ϕ_m	Phase margin at unity gain	$R_L = 50\text{ k}\Omega$	$C_L = 100\text{ pF}$	25°C	57°			
	Gain margin			25°C	11			

† Full range is 0°C to 70°C.

TLC226x, TLC226xA
Advanced LinCMOS™ RAIL-TO-RAIL
OPERATIONAL AMPLIFIERS

SLOS177A – FEBRUARY 1997 – REVISED JULY 1999

TLC2264C electrical characteristics at specified free-air temperature, $V_{DD} = 5\text{ V}$ (unless otherwise noted)

PARAMETER	TEST CONDITIONS	T_A †	TLC2264C			UNIT
			MIN	TYP	MAX	
V_{IO} Input offset voltage	$V_{IC} = 0,$ $V_O = 0,$ $V_{DD\pm} = \pm 2.5\text{ V},$ $R_S = 50\ \Omega$	25°C		300	2500	μV
		Full range			3000	
$\alpha_{V_{IO}}$ Temperature coefficient of input offset voltage		25°C to 70°C		2		$\mu\text{V}/^\circ\text{C}$
Input offset voltage long-term drift (see Note 4)		25°C		0.003		$\mu\text{V}/\text{mo}$
I_{IO} Input offset current		25°C		0.5		pA
		Full range			100	
I_{IB} Input bias current		25°C		1		pA
		Full range			100	
V_{ICR} Common-mode input voltage range	$R_S = 50\ \Omega,$ $ V_{IO} \leq 5\text{ mV}$	25°C	0 to 4	-0.3 to 4.2	V	
		Full range	0 to 3.5			
V_{OH} High-level output voltage	$I_{OH} = -20\ \mu\text{A}$ $I_{OH} = -100\ \mu\text{A}$ $I_{OH} = -400\ \mu\text{A}$	25°C		4.99	V	
		25°C	4.85	4.94		
		Full range	4.82			
		25°C	4.70	4.85		
V_{OL} Low-level output voltage	$V_{IC} = 2.5\text{ V},$ $I_{OL} = 50\ \mu\text{A}$ $I_{OL} = 500\ \mu\text{A}$ $I_{OL} = 1\text{ mA}$ $I_{OL} = 4\text{ mA}$	25°C		0.01	V	
		25°C	0.09	0.15		
		Full range		0.15		
		25°C		0.2 0.3		
		Full range		0.3		
		25°C		0.7 1		
		Full range		1.2		
		A_{VD} Large-signal differential voltage amplification	$V_{IC} = 2.5\text{ V},$ $V_O = 1\text{ V to }4\text{ V}$ $R_L = 50\ \text{k}\Omega^\ddagger$ $R_L = 1\ \text{M}\Omega^\ddagger$	25°C		80
Full range	55					
25°C				550		
$r_{i(d)}$ Differential input resistance		25°C		10^{12}	Ω	
$r_{i(c)}$ Common-mode input resistance		25°C		10^{12}	Ω	
$c_{i(c)}$ Common-mode input capacitance	$f = 10\text{ kHz},$ N package	25°C		8	pF	
z_o Closed-loop output impedance	$f = 100\text{ kHz},$ $A_V = 10$	25°C		240	Ω	
CMRR Common-mode rejection ratio	$V_{IC} = 0\text{ to }2.7\text{ V},$ $V_O = 2.5\text{ V},$ $R_S = 50\ \Omega$	25°C	70	83	dB	
		Full range	70			
k_{SVR} Supply-voltage rejection ratio ($\Delta V_{DD}/\Delta V_{IO}$)	$V_{DD} = 4.4\text{ V to }16\text{ V},$ $V_{IC} = V_{DD}/2,$ No load	25°C	80	95	dB	
		Full range	80			
I_{DD} Supply current (four amplifiers)	$V_O = 2.5\text{ V},$ No load	25°C	0.8	1	mA	
		Full range		1		

† Full range is 0°C to 70°C.

‡ Referenced to 2.5 V

NOTE 4. Typical values are based on the input offset voltage shift observed through 500 hours of operating life test at $T_A = 150^\circ\text{C}$ extrapolated to $T_A = 25^\circ\text{C}$ using the Arrhenius equation and assuming an activation energy of 0.96 eV.



TLC226x, TLC226xA
Advanced LinCMOS™ RAIL-TO-RAIL
OPERATIONAL AMPLIFIERS

SLOS177A – FEBRUARY 1997 – REVISED JULY 1999

TLC2264C operating characteristics at specified free-air temperature, $V_{DD} = 5\text{ V}$

PARAMETER		TEST CONDITIONS		T_A †	TLC2264C			UNIT
					MIN	TYP	MAX	
SR	Slew rate at unity gain	$V_O = 1.4\text{ V to }2.6\text{ V}, R_L = 50\text{ k}\Omega^\ddagger, C_L = 100\text{ pF}^\ddagger$		25°C	0.35	0.55	V/ μs	
				Full range	0.3			
V_n	Equivalent input noise voltage			25°C	40		nV/ $\sqrt{\text{Hz}}$	
				25°C	12			
$V_{N(PP)}$	Peak-to-peak equivalent input noise voltage			25°C	0.7		μV	
				25°C	1.3			
I_n	Equivalent input noise current			25°C	0.6		fA/ $\sqrt{\text{Hz}}$	
THD + N	Total harmonic distortion plus noise	$V_O = 0.5\text{ V to }2.5\text{ V}, f = 20\text{ kHz}, R_L = 50\text{ k}\Omega^\ddagger$		25°C	$A_V = 1$	0.017%		
					$A_V = 10$	0.03%		
Gain-bandwidth product		$f = 10\text{ kHz}, C_L = 100\text{ pF}^\ddagger$		25°C	0.71		MHz	
BOM	Maximum output-swing bandwidth	$V_{O(PP)} = 2\text{ V}, R_L = 50\text{ k}\Omega^\ddagger,$		$A_V = 1, C_L = 100\text{ pF}^\ddagger$	25°C	185		kHz
t_s	Settling time	$A_V = -1, \text{ Step} = 0.5\text{ V to }2.5\text{ V}, R_L = 50\text{ k}\Omega^\ddagger, C_L = 100\text{ pF}^\ddagger$		25°C	To 0.1%	6.4	μs	
					To 0.01%	14.1		
ϕ_m	Phase margin at unity gain	$R_L = 50\text{ k}\Omega^\ddagger, C_L = 100\text{ pF}^\ddagger$		25°C	56°			
	Gain margin			25°C	11		dB	

† Full range is 0°C to 70°C.

‡ Referenced to 2.5 V

TLC226x, TLC226xA
Advanced LinCMOS™ RAIL-TO-RAIL
OPERATIONAL AMPLIFIERS

SLOS177A – FEBRUARY 1997 – REVISED JULY 1999

TLC2264C electrical characteristics at specified free-air temperature, $V_{DD\pm} = \pm 5\text{ V}$ (unless otherwise specified)

PARAMETER	TEST CONDITIONS	T _A †	TLC2264C			UNIT
			MIN	TYP	MAX	
V _{IO} Input offset voltage	V _{IC} = 0, R _S = 50 Ω, V _O = 0,	25°C	300	2500	μV	
		Full range	3000			
α _{VIO} Temperature coefficient of input offset voltage		25°C to 70°C	2		μV/°C	
Input offset voltage long-term drift (see Note 4)		25°C	0.003		μV/mo	
I _{IO} Input offset current		25°C	0.5		pA	
		Full range	100			
I _{IB} Input bias current		25°C	1		pA	
		Full range	100			
V _{ICR} Common-mode input voltage range	V _{IO} ≤ 5 mV, R _S = 50 Ω	25°C	-5 to 4	-5.3 to 4.2	V	
		Full range	-5 to 3.5			
V _{OM+} Maximum positive peak output voltage	I _O = -20 μA	25°C	4.99		V	
	I _O = -100 μA	25°C	4.85	4.94		
		Full range	4.82			
	I _O = -400 μA	25°C	4.7	4.85		
Full range		4.6				
V _{OM-} Maximum negative peak output voltage	V _{IC} = 0, I _O = 50 μA	25°C	-4.99		V	
		25°C	-4.85	-4.91		
	V _{IC} = 0, I _O = 500 μA	Full range	-4.85			
		25°C	-4.7	-4.8		
	V _{IC} = 0, I _O = 1 mA	Full range	-4.7			
		25°C	-4	-4.3		
V _{IC} = 0, I _O = 4 mA	Full range	-3.8				
	A _{VD} Large-signal differential voltage amplification	V _O = ±4 V	R _L = 50 kΩ	25°C	80	200
Full range				55		
R _L = 1 MΩ			25°C	1000		
r _{i(d)} Differential input resistance		25°C	10 ¹²		Ω	
r _{i(c)} Common-mode input resistance		25°C	10 ¹²		Ω	
c _{i(c)} Common-mode input capacitance	f = 10 kHz, N package	25°C	8		pF	
z _o Closed-loop output impedance	f = 100 kHz, A _V = 10	25°C	220		Ω	
CMRR Common-mode rejection ratio	V _{IC} = -5 V to 2.7 V, V _O = 0, R _S = 50 Ω	25°C	75	88	dB	
		Full range	75			
k _{SVR} Supply-voltage rejection ratio (ΔV _{DD±} /ΔV _{IO})	V _{DD±} = ±2.2 V to ±8 V, V _{IC} = 0, No load	25°C	80	95	dB	
		Full range	80			
I _{DD} Supply current (four amplifiers)	V _O = 0, No load	25°C	0.85	1	mA	
		Full range	1			

† Full range is 0°C to 70°C.

NOTE 4: Typical values are based on the input offset voltage shift observed through 500 hours of operating life test at T_A = 150°C extrapolated to T_A = 25°C using the Arrhenius equation and assuming an activation energy of 0.96 eV.



TLC226x, TLC226xA
Advanced LinCMOS™ RAIL-TO-RAIL
OPERATIONAL AMPLIFIERS

SLOS177A – FEBRUARY 1997 – REVISED JULY 1999

TLC2264C operating characteristics at specified free-air temperature, $V_{DD\pm} = \pm 5\text{ V}$

PARAMETER		TEST CONDITIONS		T_A †	TLC2264C			UNIT
					MIN	TYP	MAX	
SR	Slew rate at unity gain	$V_O = \pm 1.9\text{ V}$, $C_L = 100\text{ pF}$	$R_L = 50\text{ k}\Omega$	25°C	0.35	0.55	$\text{V}/\mu\text{s}$	
				Full range	0.3			
V_n	Equivalent input noise voltage	$f = 10\text{ Hz}$		25°C	43		$\text{nV}/\sqrt{\text{Hz}}$	
		$f = 1\text{ kHz}$		25°C	12			
$V_{N(PP)}$	Peak-to-peak equivalent input noise voltage	$f = 0.1\text{ Hz to }1\text{ Hz}$		25°C	0.8		μV	
		$f = 0.1\text{ Hz to }10\text{ Hz}$		25°C	1.3			
I_n	Equivalent input noise current			25°C	0.6		$\text{fA}/\sqrt{\text{Hz}}$	
THD + N	Total harmonic distortion plus noise	$V_O = \pm 2.3\text{ V}$, $f = 20\text{ kHz}$, $R_L = 50\text{ k}\Omega$		25°C	$A_V = 1$	0.014%		
					$A_V = 10$	0.024%		
	Gain-bandwidth product	$f = 10\text{ kHz}$, $C_L = 100\text{ pF}$	$R_L = 50\text{ k}\Omega$	25°C	0.73		MHz	
B_{OM}	Maximum output-swing bandwidth	$V_{O(PP)} = 4.6\text{ V}$, $R_L = 50\text{ k}\Omega$	$A_V = 1$, $C_L = 100\text{ pF}$	25°C	70		kHz	
t_s	Settling time	$A_V = -1$, Step = $-2.3\text{ V to }2.3\text{ V}$, $R_L = 50\text{ k}\Omega$, $C_L = 100\text{ pF}$		25°C	To 0.1%	7.1		μs
					To 0.01%	16.5		
ϕ_m	Phase margin at unity gain	$R_L = 50\text{ k}\Omega$	$C_L = 100\text{ pF}$	25°C	57°			
	Gain margin			25°C	11		dB	

† Full range is 0°C to 70°C.

TLC226x, TLC226xA Advanced LinCMOS™ RAIL-TO-RAIL OPERATIONAL AMPLIFIERS

SLOS177A – FEBRUARY 1997 – REVISED JULY 1999

TLC2262I electrical characteristics at specified free-air temperature, $V_{DD} = 5\text{ V}$ (unless otherwise noted)

PARAMETER	TEST CONDITIONS	T_A †	TLC2262I			TLC2262AI			UNIT
			MIN	TYP	MAX	MIN	TYP	MAX	
V_{IO} Input offset voltage	$V_{DD} \pm = \pm 2.5\text{ V}$, $V_{IC} = 0$, $V_O = 0$, $R_S = 50\ \Omega$	25°C	300	2500		300	950	μV	
		Full range			3000		1500		
α_{VIO} Temperature coefficient of input offset voltage		25°C to 85°C	2			2		$\mu\text{V}/^\circ\text{C}$	
Input offset voltage long-term drift (see Note 4)		25°C	0.003			0.003		$\mu\text{V}/\text{mo}$	
I_{IO} Input offset current		25°C	0.5			0.5		pA	
		Full range			500		500		
I_{IB} Input bias current	25°C	1			1		pA		
	Full range			500		500			
V_{ICR} Common-mode input voltage range	$R_S = 50\ \Omega$, $ V_{IO} \leq 5\text{ mV}$	25°C	0 to 4	-0.3 to 4.2		0 to 4	-0.3 to 4.2	V	
		Full range	0 to 3.5			0 to 3.5			
V_{OH} High-level output voltage	$I_{OH} = -20\ \mu\text{A}$	25°C	4.99			4.99		V	
		25°C	4.85	4.94		4.85	4.94		
		Full range	4.82			4.82			
		25°C	4.7	4.85		4.7	4.85		
V_{OL} Low-level output voltage	$V_{IC} = 2.5\text{ V}$, $I_{OL} = 50\ \mu\text{A}$	25°C	0.01			0.01		V	
		25°C	0.09	0.15		0.09	0.15		
		Full range		0.15			0.15		
		25°C	0.8	1		0.7	1		
V_{OL} Low-level output voltage	$V_{IC} = 2.5\text{ V}$, $I_{OL} = 500\ \mu\text{A}$	25°C	0.01			0.01		V	
		25°C	0.09	0.15		0.09	0.15		
		Full range		0.15			0.15		
		25°C	0.8	1		0.7	1		
V_{OL} Low-level output voltage	$V_{IC} = 2.5\text{ V}$, $I_{OL} = 4\text{ mA}$	25°C	0.8	1		0.7	1	V	
		25°C	0.8	1		0.7	1		
		Full range		1.2			1.2		
		25°C	0.8	1		0.7	1		
A_{VD} Large-signal differential voltage amplification	$V_{IC} = 2.5\text{ V}$, $V_O = 1\text{ V to }4\text{ V}$	$R_L = 50\text{ k}\Omega$ ‡	25°C	80	100		80	170	V/mV
			Full range	50			50		
		$R_L = 1\text{ M}\Omega$ ‡	25°C	550			550		
$r_{i(d)}$ Differential input resistance		25°C	10 ¹²			10 ¹²	Ω		
$r_{i(c)}$ Common-mode input resistance		25°C	10 ¹²			10 ¹²	Ω		
$c_{i(c)}$ Common-mode input capacitance	$f = 10\text{ kHz}$, P package	25°C	8			8	pF		
z_o Closed-loop output impedance	$f = 100\text{ kHz}$, $A_V = 10$	25°C	240			240	Ω		
CMRR Common-mode rejection ratio	$V_{IC} = 0\text{ to }2.7\text{ V}$, $V_O = 2.5\text{ V}$, $R_S = 50\ \Omega$	25°C	70	83		70	83	dB	
		Full range	70			70			
k_{SVR} Supply-voltage rejection ratio ($\Delta V_{DD}/\Delta V_{IO}$)	$V_{DD} = 4.4\text{ V to }16\text{ V}$, $V_{IC} = V_{DD}/2$, No load	25°C	80	95		80	95	dB	
		Full range	80			80			
I_{DD} Supply current	$V_O = 2.5\text{ V}$, No load	25°C	400	500		400	500	μA	
		Full range			500		500		

† Full range is -40°C to 125°C .

‡ Referenced to 2.5 V

NOTE 4: Typical values are based on the input offset voltage shift observed through 500 hours of operating life test at $T_A = 150^\circ\text{C}$ extrapolated to $T_A = 25^\circ\text{C}$ using the Arrhenius equation and assuming an activation energy of 0.96 eV.



TLC2262I operating characteristics at specified free-air temperature, $V_{DD} = 5\text{ V}$

PARAMETER	TEST CONDITIONS	T_A †	TLC2262I			TLC2262AI			UNIT
			MIN	TYP	MAX	MIN	TYP	MAX	
SR	Slew rate at unity gain $V_O = 1.5\text{ V to }3.5\text{ V}, R_L = 50\text{ k}\Omega\ddagger, C_L = 100\text{ pF}\ddagger$	25°C	0.35	0.55		0.35	0.55		$\text{V}/\mu\text{s}$
		Full range	0.25			0.25			
V_n	Equivalent input noise voltage	$f = 10\text{ Hz}$	40			40			$\text{nV}/\sqrt{\text{Hz}}$
		$f = 1\text{ kHz}$	12			12			
$V_{N(PP)}$	Peak-to-peak equivalent input noise voltage	$f = 0.1\text{ Hz to }1\text{ Hz}$	0.7			0.7			μV
		$f = 0.1\text{ Hz to }10\text{ Hz}$	1.3			1.3			
I_n	Equivalent input noise current	25°C	0.6			0.6			$\text{fA}/\sqrt{\text{Hz}}$
THD + N	Total harmonic distortion plus noise $V_O = 0.5\text{ V to }2.5\text{ V}, f = 20\text{ kHz}, R_L = 50\text{ k}\Omega\ddagger$	$A_V = 1$	0.017%			0.017%			
		$A_V = 10$	0.03%			0.03%			
	Gain-bandwidth product $f = 50\text{ kHz}, C_L = 100\text{ pF}\ddagger$	$R_L = 50\text{ k}\Omega\ddagger, 25^\circ\text{C}$	0.82			0.82			MHz
BOM	Maximum output-swing bandwidth $V_{O(PP)} = 2\text{ V}, R_L = 50\text{ k}\Omega\ddagger$	$A_V = 1, C_L = 100\text{ pF}\ddagger, 25^\circ\text{C}$	185			185			kHz
t_s	Settling time $A_V = -1, \text{ Step} = 0.5\text{ V to }2.5\text{ V}, R_L = 50\text{ k}\Omega\ddagger, C_L = 100\text{ pF}\ddagger$	To 0.1%	6.4			6.4			μs
		To 0.01%	14.1			14.1			
ϕ_m	Phase margin at unity gain $R_L = 50\text{ k}\Omega\ddagger, C_L = 100\text{ pF}\ddagger$	25°C	56°			56°			
	Gain margin	25°C	11			11			

† Full range is – 40°C to 125°C.

‡ Referenced to 2.5 V

TLC226x, TLC226xA Advanced LinCMOS™ RAIL-TO-RAIL OPERATIONAL AMPLIFIERS

SLOS177A – FEBRUARY 1997 – REVISED JULY 1999

TLC2262I electrical characteristics at specified free-air temperature, $V_{DD\pm} = \pm 5\text{ V}$ (unless otherwise noted)

PARAMETER	TEST CONDITIONS	T_A †	TLC2262I			TLC2262AI			UNIT
			MIN	TYP	MAX	MIN	TYP	MAX	
V_{IO} Input offset voltage	$V_{IC} = 0, V_O = 0, R_S = 50\ \Omega$	25°C	300	2500		300	950	μV	
		Full range			3000		1500		
αV_{IO} Temperature coefficient of input offset voltage		25°C to 85°C	2		2		$\mu\text{V}/^\circ\text{C}$		
Input offset voltage long-term drift (see Note 4)		25°C	0.003		0.003		$\mu\text{V}/\text{mo}$		
I_{IO} Input offset current		25°C	0.5		0.5		pA		
		Full range	500		500				
I_{IB} Input bias current		25°C	1		1		pA		
		Full range	500		500				
V_{ICR} Common-mode input voltage range	$R_S = 50\ \Omega, V_{IO} \leq 5\ \text{mV}$	25°C	-5 to 4	-5.3 to 4.2	-5 to 4	-5.3 to 4.2	V		
		Full range	-5 to 3.5		-5 to 3.5				
V_{OM+} Maximum positive peak output voltage	$I_O = -20\ \mu\text{A}$	25°C	4.99		4.99		V		
		25°C	4.85	4.94	4.85	4.94			
		Full range	4.82		4.82				
		25°C	4.7	4.85	4.7	4.85			
V_{OM-} Maximum negative peak output voltage	$I_O = -400\ \mu\text{A}$	25°C	-4.99		-4.99		V		
		25°C	-4.85	-4.91	-4.85	-4.91			
		Full range	-4.85		-4.85				
		25°C	-4	-4.3	-4	-4.3			
V_{OM-} Maximum negative peak output voltage	$I_O = 50\ \mu\text{A}$	25°C	-4.99		-4.99		V		
		25°C	-4.85	-4.91	-4.85	-4.91			
		Full range	-4.85		-4.85				
		25°C	-4	-4.3	-4	-4.3			
V_{OM-} Maximum negative peak output voltage	$I_O = 500\ \mu\text{A}$	25°C	-4.99		-4.99		V		
		25°C	-4.85	-4.91	-4.85	-4.91			
		Full range	-4.85		-4.85				
		25°C	-4	-4.3	-4	-4.3			
V_{OM-} Maximum negative peak output voltage	$I_O = 4\ \text{mA}$	25°C	-4.99		-4.99		V		
		25°C	-4.85	-4.91	-4.85	-4.91			
		Full range	-4.85		-4.85				
		25°C	-4	-4.3	-4	-4.3			
A_{VD} Large-signal differential voltage amplification	$V_O = \pm 4\ \text{V}$	$R_L = 50\ \text{k}\Omega$	25°C	80	200	80	200	V/mV	
			Full range	50		50			
			25°C	1000		1000			
$r_{i(d)}$ Differential input resistance		25°C	10^{12}		10^{12}		Ω		
			10^{12}		10^{12}				
$r_{i(c)}$ Common-mode input resistance		25°C	10^{12}		10^{12}		Ω		
$C_{i(c)}$ Common-mode input capacitance	$f = 10\ \text{kHz}, \text{ P package}$	25°C	8		8		pF		
z_o Closed-loop output impedance	$f = 100\ \text{kHz}, A_V = 10$	25°C	220		220		Ω		
CMRR Common-mode rejection ratio	$V_{IC} = -5\ \text{V to } 2.7\ \text{V}, V_O = 0, R_S = 50\ \Omega$	25°C	75	88	75	88	dB		
		Full range	75		75				
k_{SVR} Supply-voltage rejection ratio ($\Delta V_{DD\pm} / \Delta V_{IO}$)	$V_{DD} = 4.4\ \text{V to } 16\ \text{V}, V_{IC} = V_{DD}/2, \text{ No load}$	25°C	80	95	80	95	dB		
		Full range	80		80				
I_{DD} Supply current	$V_O = 2.5\ \text{V}, \text{ No load}$	25°C	425	500	425	500	μA		
		Full range	500		500				

† Full range is -40°C to 125°C .

NOTE 4: Typical values are based on the input offset voltage shift observed through 500 hours of operating life test at $T_A = 150^\circ\text{C}$ extrapolated to $T_A = 25^\circ\text{C}$ using the Arrhenius equation and assuming an activation energy of 0.96 eV.



TLC2262I operating characteristics at specified free-air temperature, $V_{DD\pm} = \pm 5\text{ V}$

PARAMETER	TEST CONDITIONS	T_A †	TLC2262I			TLC2262AI			UNIT
			MIN	TYP	MAX	MIN	TYP	MAX	
SR	Slew rate at unity gain $V_O = \pm 1.9\text{ V}$, $C_L = 100\text{ pF}$ $R_L = 50\text{ k}\Omega$	25°C	0.35	0.55		0.35	0.55		V/ μ s
		Full range	0.25			0.25			
V_n	Equivalent input noise voltage	f = 10 Hz	43			43			nV/ $\sqrt{\text{Hz}}$
		f = 1 kHz	12			12			
$V_{N(PP)}$	Peak-to-peak equivalent input noise voltage	f = 0.1 Hz to 1 Hz	0.8			0.8			μ V
		f = 0.1 Hz to 10 Hz	1.3			1.3			
I_n	Equivalent input noise current	25°C	0.6			0.6			fA/ $\sqrt{\text{Hz}}$
THD + N	Total harmonic distortion plus noise $V_O = \pm 2.3\text{ V}$, $R_L = 50\text{ k}\Omega$, f = 20 kHz	$A_V = 1$	0.014%			0.014%			
		$A_V = 10$	0.024%			0.024%			
	Gain-bandwidth product f = 10 kHz, $C_L = 100\text{ pF}$ $R_L = 50\text{ k}\Omega$	25°C	0.73			0.73			MHz
B_{OM}	Maximum output-swing bandwidth $V_{O(PP)} = 4.6\text{ V}$, $R_L = 50\text{ k}\Omega$ $A_V = 1$, $C_L = 100\text{ pF}$	25°C	85			85			kHz
t_s	Settling time $A_V = -1$, Step = -2.3 V to 2.3 V, $R_L = 50\text{ k}\Omega$, $C_L = 100\text{ pF}$	To 0.1%	7.1			7.1			μ s
		To 0.01%	16.5			16.5			
ϕ_m	Phase margin at unity gain $R_L = 50\text{ k}\Omega$, $C_L = 100\text{ pF}$	25°C	57°			57°			dB
		25°C	11			11			

† Full range is -40°C to 125°C.

TLC226x, TLC226xA Advanced LinCMOS™ RAIL-TO-RAIL OPERATIONAL AMPLIFIERS

SLOS177A – FEBRUARY 1997 – REVISED JULY 1999

TLC2264I electrical characteristics at specified free-air temperature, $V_{DD} = 5\text{ V}$ (unless otherwise noted)

PARAMETER	TEST CONDITIONS	T_A †	TLC2264I			TLC2264AI			UNIT	
			MIN	TYP	MAX	MIN	TYP	MAX		
V_{IO} Input offset voltage	$V_{DD} = \pm 2.5\text{ V}$, $V_O = 0$, $V_{IC} = 0$, $R_S = 50\ \Omega$	25°C	300	2500		300	950		μV	
		Full range			3000		1500			
α_{VIO} Temperature coefficient of input offset voltage		25°C to 125°C	2			2			$\mu\text{V}/^\circ\text{C}$	
Input offset voltage long-term drift (see Note 4)		25°C	0.003			0.003			$\mu\text{V}/\text{mo}$	
I_{IO} Input offset current		25°C	0.5			0.5			pA	
		Full range			500		500			
I_{IB} Input bias current		25°C	1			1			pA	
	Full range			500		500				
V_{ICR} Common-mode input voltage range	$R_S = 50\ \Omega$, $ V_{IO} \leq 5\text{ mV}$	25°C	0 to 4	-0.3 to 4.2		0 to 4	-0.3 to 4.2		V	
		Full range	0 to 3.5			0 to 3.5				
V_{OH} High-level output voltage	$I_{OH} = -20\ \mu\text{A}$	25°C	4.85	4.94		4.85	4.94		V	
		Full range	4.82			4.82				
		25°C	4.7	4.85		4.7	4.85			
		Full range	4.5			4.5				
V_{OL} Low-level output voltage	$V_{IC} = 2.5\text{ V}$, $I_{OL} = 50\ \mu\text{A}$	25°C	0.01			0.01			V	
		25°C	0.09	0.15		0.09	0.15			
		Full range		0.15			0.15			
		25°C	0.8	1		0.7	1			
A_{VD} Large-signal differential voltage amplification	$V_{IC} = 2.5\text{ V}$, $V_O = 1\text{ V to }4\text{ V}$	$R_L = 50\ \text{k}\Omega$ ‡	25°C	80	100		80	170	V/mV	
			Full range	50			50			
		$R_L = 1\ \text{M}\Omega$ ‡	25°C	550			550			
			Full range							
$r_{i(d)}$ Differential input resistance		25°C	1012			1012		Ω		
$r_{i(c)}$ Common-mode input resistance		25°C	1012			1012		Ω		
$C_{i(c)}$ Common-mode input capacitance	$f = 10\ \text{kHz}$, N package	25°C	8			8		pF		
z_o Closed-loop output impedance	$f = 100\ \text{kHz}$, $A_V = 10$	25°C	240			240		Ω		
CMRR Common-mode rejection ratio	$V_{IC} = 0\text{ to }2.7\text{ V}$, $V_O = 2.5\text{ V}$, $R_S = 50\ \Omega$	25°C	70	83		70	83	dB		
		Full range	70			70				
k_{SVR} Supply-voltage rejection ratio ($\Delta V_{DD}/\Delta V_{IO}$)	$V_{DD} = 4.4\text{ V to }16\text{ V}$, $V_{IC} = V_{DD}/2$, No load	25°C	80	95		80	95	dB		
		Full range	80			80				
I_{DD} Supply current (four amplifiers)	$V_O = 2.5\text{ V}$, No load	25°C	0.8	1		0.8	1	mA		
		Full range			1		1			

† Full range is -40°C to 125°C .

‡ Referenced to 2.5 V

NOTE 4: Typical values are based on the input offset voltage shift observed through 500 hours of operating life test at $T_A = 150^\circ\text{C}$ extrapolated to $T_A = 25^\circ\text{C}$ using the Arrhenius equation and assuming an activation energy of 0.96 eV.



TLC2264I operating characteristics at specified free-air temperature, $V_{DD} = 5\text{ V}$

PARAMETER	TEST CONDITIONS	T_A †	TLC2264I			TLC2264AI			UNIT
			MIN	TYP	MAX	MIN	TYP	MAX	
SR	Slew rate at unity gain $V_O = 1.4\text{ V to }2.6\text{ V}, R_L = 50\text{ k}\Omega^\ddagger, C_L = 100\text{ pF}^\ddagger$	25°C	0.35	0.55		0.35	0.55		V/ μs
		Full range	0.25			0.25			
V_n	Equivalent input noise voltage	f = 10 Hz	40			40			nV/ $\sqrt{\text{Hz}}$
		f = 1 kHz	12			12			
$V_{N(PP)}$	Peak-to-peak equivalent input noise voltage	f = 0.1 Hz to 1 Hz	0.7			0.7			μV
		f = 0.1 Hz to 10 Hz	1.3			1.3			
I_n	Equivalent input noise current	25°C	0.6			0.6			fA/ $\sqrt{\text{Hz}}$
THD + N	Total harmonic distortion plus noise $V_O = 0.5\text{ V to }2.5\text{ V}, f = 20\text{ kHz}, R_L = 50\text{ k}\Omega^\ddagger$	25°C	$A_V = 1$			0.017%			
			$A_V = 10$			0.03%			
	Gain-bandwidth product	25°C	0.71			0.71			MHz
BOM	Maximum output-swing bandwidth $V_{O(PP)} = 2\text{ V}, R_L = 50\text{ k}\Omega^\ddagger, A_V = 1, C_L = 100\text{ pF}^\ddagger$	25°C	185			185			kHz
t_s	Settling time $A_V = -1, \text{ Step} = 0.5\text{ V to }2.5\text{ V}, R_L = 50\text{ k}\Omega^\ddagger, C_L = 100\text{ pF}^\ddagger$	25°C	$T_o = 0.1\%$			6.4			μs
			$T_o = 0.01\%$			14.1			
ϕ_m	Phase margin at unity gain $R_L = 50\text{ k}\Omega^\ddagger, C_L = 100\text{ pF}^\ddagger$	25°C	56°			56°			
		25°C	11			11			

† Full range is –40°C to 125°C.

‡ Referenced to 2.5 V

TLC226x, TLC226xA Advanced LinCMOS™ RAIL-TO-RAIL OPERATIONAL AMPLIFIERS

SLOS177A – FEBRUARY 1997 – REVISED JULY 1999

TLC2264I electrical characteristics at specified free-air temperature, $V_{DD\pm} = \pm 5\text{ V}$ (unless otherwise noted)

PARAMETER	TEST CONDITIONS	T_A †	TLC2264I			TLC2264AI			UNIT
			MIN	TYP	MAX	MIN	TYP	MAX	
V_{IO} Input offset voltage	$V_{IC} = 0, V_O = 0, R_S = 50\ \Omega$	25°C	300	2500	300	950	μV		
		Full range	3000		1500				
αV_{IO} Temperature coefficient of input offset voltage		25°C to 125°C	2		2		$\mu\text{V}/^\circ\text{C}$		
Input offset voltage long-term drift (see Note 4)		25°C	0.003		0.003		$\mu\text{V}/\text{mo}$		
I_{IO} Input offset current		25°C	0.5		0.5		pA		
		Full range	500		500				
I_{IB} Input bias current	25°C	1		1		pA			
	Full range	500		500					
V_{ICR} Common-mode input voltage range	$R_S = 50\ \Omega, V_{IO} \leq 5\ \text{mV}$	25°C	-5 to 4	-5.3 to 4.2	-5 to 4	-5.3 to 4.2	V		
		Full range	-5 to 3.5	-5 to 3.5	-5 to 3.5	-5 to 3.5			
V_{OM+} Maximum positive peak output voltage	$I_O = -20\ \mu\text{A}$	25°C	4.99		4.99		V		
		25°C	4.85	4.94	4.85	4.94			
		Full range	4.82		4.82				
		25°C	4.7	4.85	4.7	4.85			
V_{OM-} Maximum negative peak output voltage	$I_O = -400\ \mu\text{A}$	25°C	-4.99		-4.99		V		
		25°C	-4.85	-4.91	-4.85	-4.91			
		Full range	-4.85		-4.85				
		25°C	-4	-4.3	-4	-4.3			
V_{AVD} Large-signal differential voltage amplification	$V_O = \pm 4\ \text{V}$	$R_L = 50\ \text{k}\Omega$	25°C	80	200	80	200	V/mV	
			Full range	50		50			
		$R_L = 1\ \text{M}\Omega$	25°C	1000		1000			
			Full range	50		50			
$r_{i(d)}$ Differential input resistance		25°C	10^{12}		10^{12}		Ω		
$r_{i(c)}$ Common-mode input resistance		25°C	10^{12}		10^{12}		Ω		
$c_{i(c)}$ Common-mode input capacitance	$f = 10\ \text{kHz}, \text{N package}$	25°C	8		8		pF		
z_o Closed-loop output impedance	$f = 100\ \text{kHz}, A_V = 10$	25°C	220		220		Ω		
CMRR Common-mode rejection ratio	$V_{IC} = -5\ \text{V to } 2.7\ \text{V}, V_O = 0, R_S = 50\ \Omega$	25°C	75	88	75	88	dB		
		Full range	75		75				
k_{SVR} Supply-voltage rejection ratio ($\Delta V_{DD\pm}/\Delta V_{IO}$)	$V_{DD\pm} = \pm 2.2\ \text{V to } \pm 8\ \text{V}, V_{IC} = V_{DD}/2, \text{No load}$	25°C	80	95	80	95	dB		
		Full range	80		80				
I_{DD} Supply current (four amplifiers)	$V_O = 0, \text{No load}$	25°C	0.85	1	0.85	1	mA		
		Full range	1		1				

† Full range is -40°C to 125°C .

NOTE 4: Typical values are based on the input offset voltage shift observed through 500 hours of operating life test at $T_A = 150^\circ\text{C}$ extrapolated to $T_A = 25^\circ\text{C}$ using the Arrhenius equation and assuming an activation energy of 0.96 eV.



TLC2264I operating characteristics at specified free-air temperature, $V_{DD\pm} = \pm 5\text{ V}$

PARAMETER	TEST CONDITIONS	T_A †	TLC2264I			TLC2264AI			UNIT		
			MIN	TYP	MAX	MIN	TYP	MAX			
SR	Slew rate at unity gain $V_O = \pm 1.9\text{ V}$, $C_L = 100\text{ pF}$	$R_L = 50\text{ k}\Omega$	25°C	0.35	0.55		0.35	0.55	V/ μs		
			Full range	0.25			0.25				
V_n	Equivalent input noise voltage		25°C	43			43			nV/ $\sqrt{\text{Hz}}$	
			$f = 1\text{ kHz}$	12			12				
$V_{N(PP)}$	Peak-to-peak equivalent input noise voltage		25°C	0.8			0.8			μV	
			$f = 0.1\text{ Hz to }10\text{ Hz}$	1.3			1.3				
I_n	Equivalent input noise current		25°C	0.6			0.6			fA/ $\sqrt{\text{Hz}}$	
THD + N	Total harmonic distortion plus noise $V_O = \pm 2.3\text{ V}$, $R_L = 50\text{ k}\Omega$, $f = 20\text{ kHz}$		25°C	$A_V = 1$	0.014%			0.014%			
				$A_V = 10$	0.024%			0.024%			
	Gain-bandwidth product $f = 10\text{ kHz}$, $C_L = 100\text{ pF}$	$R_L = 50\text{ k}\Omega$	25°C	0.73			0.73			MHz	
BOM	Maximum output-swing bandwidth $V_{O(PP)} = 4.6\text{ V}$, $R_L = 50\text{ k}\Omega$	$A_V = 1$, $C_L = 100\text{ pF}$	25°C	70			70			kHz	
t_s	Settling time $A_V = -1$, Step = $-2.3\text{ V to }2.3\text{ V}$, $R_L = 50\text{ k}\Omega$, $C_L = 100\text{ pF}$		25°C	To 0.1%	7.1			7.1			μs
				To 0.01%	16.5			16.5			
ϕ_m	Phase margin at unity gain $R_L = 50\text{ k}\Omega$	$C_L = 100\text{ pF}$	25°C	57°			57°				
	Gain margin		25°C	11			11				dB

† Full range is -40°C to 125°C .

TLC226x, TLC226xA Advanced LinCMOS™ RAIL-TO-RAIL OPERATIONAL AMPLIFIERS

SLOS177A – FEBRUARY 1997 – REVISED JULY 1999

TLC2262Q/M electrical characteristics at specified free-air temperature, $V_{DD} = 5\text{ V}$ (unless otherwise noted)

PARAMETER	TEST CONDITIONS	T_A †	TLC2262Q, TLC2262M			TLC2262AQ, TLC2262AM			UNIT
			MIN	TYP	MAX	MIN	TYP	MAX	
V_{IO} Input offset voltage	$V_{DD\pm} = \pm 2.5\text{ V}$, $V_O = 0$, $V_{IC} = 0$, $R_S = 50\ \Omega$	25°C	300	2500		300	950	μV	
		Full range			3000		1500		
α_{VIO} Temperature coefficient of input offset voltage		Full range		5			5	$\mu\text{V}/^\circ\text{C}$	
Input offset voltage long-term drift (see Note 4)		25°C		0.003			0.003	$\mu\text{V}/\text{mo}$	
I_{IO} Input offset current		25°C		0.5			0.5	pA	
		125°C			500		500		
I_{IB} Input bias current	25°C		1			1	pA		
	125°C			500		500			
V_{ICR} Common-mode input voltage range	$R_S = 50\ \Omega$, $ V_{IO} \leq 5\text{ mV}$	25°C	0 to 4	-0.3 to 4.2		0 to 4	-0.3 to 4.2	V	
		Full range	0 to 3.5			0 to 3.5			
V_{OH} High-level output voltage	$I_{OH} = -20\ \mu\text{A}$	25°C		4.99			4.99	V	
		25°C	4.85	4.94		4.85	4.94		
		Full range	4.82			4.82			
		25°C	4.7	4.85		4.7	4.85		
V_{OL} Low-level output voltage	$V_{IC} = 2.5\text{ V}$, $I_{OL} = 50\ \mu\text{A}$	25°C		0.01			0.01	V	
		25°C		0.09	0.15		0.09		0.15
		Full range			0.15				0.15
		25°C		0.8	1		0.7		1
AVD Large-signal differential voltage amplification	$V_{IC} = 2.5\text{ V}$, $V_O = 1\text{ V to }4\text{ V}$	$R_L = 50\ \text{k}\Omega^\ddagger$	25°C	80	100		80	170	V/mV
			Full range	50			50		
		$R_L = 1\ \text{M}\Omega^\ddagger$	25°C		550			550	
			Full range						
$r_{i(d)}$ Differential input resistance		25°C		10 ¹²			10 ¹²	Ω	
$r_{i(c)}$ Common-mode input resistance		25°C		10 ¹²			10 ¹²	Ω	
$c_{i(c)}$ Common-mode input capacitance	$f = 10\ \text{kHz}$, P package	25°C		8			8	pF	
z_o Closed-loop output impedance	$f = 100\ \text{kHz}$, $A_V = 10$	25°C		240			240	Ω	
CMRR Common-mode rejection ratio	$V_{IC} = 0\text{ to }2.7\text{ V}$, $V_O = 2.5\text{ V}$, $R_S = 50\ \Omega$	25°C	70	83		70	83	dB	
		Full range	70			70			
k_{SVR} Supply-voltage rejection ratio ($\Delta V_{DD}/\Delta V_{IO}$)	$V_{DD} = 4.4\text{ V to }16\text{ V}$, $V_{IC} = V_{DD}/2$, No load	25°C	80	95		80	95	dB	
		Full range	80			80			

† Full range is -40°C to 125°C for Q suffix, -55°C to 125°C for M suffix.

‡ Referenced to 2.5 V

NOTE 4: Typical values are based on the input offset voltage shift observed through 500 hours of operating life test at $T_A = 150^\circ\text{C}$ extrapolated to $T_A = 25^\circ\text{C}$ using the Arrhenius equation and assuming an activation energy of 0.96 eV.



TLC2262Q/M electrical characteristics at specified free-air temperature, $V_{DD} = 5\text{ V}$ (unless otherwise noted) (continued)

PARAMETER	TEST CONDITIONS	T_A †	TLC2262Q, TLC2262M			TLC2262AQ, TLC2262AM			UNIT
			MIN	TYP	MAX	MIN	TYP	MAX	
I_{DD} Supply current	$V_O = 2.5\text{ V}$, No load	25°C	400	500		400	500	μA	
		Full range		500			500		

† Full range is -40°C to 125°C for Q suffix, -55°C to 125°C for M suffix.

TLC2262Q/M operating characteristics at specified free-air temperature, $V_{DD} = 5\text{ V}$

PARAMETER	TEST CONDITIONS	T_A †	TLC2262Q, TLC2262M			TLC2262AQ, TLC2262AM			UNIT
			MIN	TYP	MAX	MIN	TYP	MAX	
SR Slew rate at unity gain	$V_O = 0.5\text{ V}$ to 3.5 V , $C_L = 100\text{ pF}^\ddagger$, $R_L = 50\text{ k}\Omega^\ddagger$	25°C	0.35	0.55		0.35	0.55	$\text{V}/\mu\text{s}$	
		Full range	0.25			0.25			
V_n Equivalent input noise voltage	$f = 10\text{ Hz}$ $f = 1\text{ kHz}$	25°C		40			40	$\text{nV}/\sqrt{\text{Hz}}$	
		25°C		12			12		
$V_{N(PP)}$ Peak-to-peak equivalent input noise voltage	$f = 0.1\text{ Hz}$ to 1 Hz $f = 0.1\text{ Hz}$ to 10 Hz	25°C		0.7			0.7	μV	
		25°C		1.3			1.3		
I_n Equivalent input noise current		25°C		0.6			0.6	$\text{fA}/\sqrt{\text{Hz}}$	
THD + N Total harmonic distortion plus noise	$V_O = 0.5\text{ V}$ to 2.5 V , $f = 20\text{ kHz}$, $R_L = 50\text{ k}\Omega^\ddagger$	25°C		$A_V = 1$		0.017%		0.017%	
				$A_V = 10$		0.03%		0.03%	
Gain-bandwidth product	$f = 50\text{ kHz}$, $C_L = 100\text{ pF}^\ddagger$, $R_L = 50\text{ k}\Omega^\ddagger$	25°C		0.82			0.82	MHz	
B_{OM} Maximum output-swing bandwidth	$V_{O(PP)} = 2\text{ V}$, $R_L = 50\text{ k}\Omega^\ddagger$, $A_V = 1$, $C_L = 100\text{ pF}^\ddagger$	25°C		185			185	kHz	
t_s Settling time	$A_V = -1$, Step = 0.5 V to 2.5 V , $R_L = 50\text{ k}\Omega^\ddagger$, $C_L = 100\text{ pF}^\ddagger$	25°C		To 0.1%		6.4		6.4	μs
				To 0.01%		14.1		14.1	
ϕ_m Phase margin at unity gain	$R_L = 50\text{ k}\Omega^\ddagger$, $C_L = 100\text{ pF}^\ddagger$	25°C		56°			56°		
		25°C		11			11		
Gain margin		25°C		11			11	dB	

† Full range is -40°C to 125°C for Q suffix, -55°C to 125°C for M suffix.

‡ Referenced to 2.5 V

TLC226x, TLC226xA Advanced LinCMOS™ RAIL-TO-RAIL OPERATIONAL AMPLIFIERS

SLOS177A – FEBRUARY 1997 – REVISED JULY 1999

TLC2262Q/M electrical characteristics at specified free-air temperature, $V_{DD\pm} = \pm 5\text{ V}$ (unless otherwise noted)

PARAMETER	TEST CONDITIONS	T_A †	TLC2262Q, TLC2262M			TLC2262AQ, TLC2262AM			UNIT
			MIN	TYP	MAX	MIN	TYP	MAX	
V_{IO} Input offset voltage	$V_{IC} = 0, V_O = 0, R_S = 50\ \Omega$	25°C	300	2500		300	950	μV	
		Full range			3000		1500		
α_{VIO} Temperature coefficient of input offset voltage		Full range		5			5	$\mu\text{V}/^\circ\text{C}$	
Input offset voltage long-term drift (see Note 4)		25°C		0.003			0.003	$\mu\text{V}/\text{mo}$	
I_{IO} Input offset current		25°C		0.5			0.5	pA	
		125°C			500		500		
I_{IB} Input bias current	25°C		1			1	pA		
	125°C			500		500			
V_{ICR} Common-mode input voltage range	$R_S = 50\ \Omega, V_{IO} \leq 5\ \text{mV}$	25°C	-5 to 4	-5.3 to 4.2		-5 to 4	-5.3 to 4.2	V	
		Full range	-5 to 3.5			-5 to 3.5			
V_{OM+} Maximum positive peak output voltage	$I_O = -20\ \mu\text{A}$	25°C		4.99			4.99	V	
	$I_O = -100\ \mu\text{A}$	25°C	4.85	4.94		4.85	4.94		
		Full range	4.82			4.82			
	$I_O = -400\ \mu\text{A}$	25°C	4.7	4.85		4.7	4.85		
V_{OM-} Maximum negative peak output voltage	$V_{IC} = 0, I_O = 50\ \mu\text{A}$	25°C		-4.99			-4.99	V	
		25°C	-4.85	-4.91		-4.85	-4.91		
	$V_{IC} = 0, I_O = 500\ \mu\text{A}$	Full range	-4.85			-4.85			
		25°C	-4	-4.3		-4	-4.3		
$V_{IC} = 0, I_O = 4\ \text{mA}$	Full range	-3.8			-3.8				
A_{VD} Large-signal differential voltage amplification	$V_O = \pm 4\ \text{V}$	$R_L = 50\ \text{k}\Omega$	25°C	80	200		80	200	V/mV
			Full range	50			50		
		$R_L = 1\ \text{M}\Omega$	25°C		1000			1000	
$r_{i(d)}$ Differential input resistance		25°C		10^{12}			10^{12}	Ω	
$r_{i(c)}$ Common-mode input resistance		25°C		10^{12}			10^{12}	Ω	
$C_{i(c)}$ Common-mode input capacitance	$f = 10\ \text{kHz}, \text{ P package}$	25°C		8			8	pF	
z_o Closed-loop output impedance	$f = 100\ \text{kHz}, A_V = 10$	25°C		220			220	Ω	
CMRR Common-mode rejection ratio	$V_{IC} = -5\ \text{V to } 2.7\ \text{V}, V_O = 0, R_S = 50\ \Omega$	25°C	75	88		75	88	dB	
		Full range	75			75			
k_{SVR} Supply-voltage rejection ratio ($\Delta V_{DD\pm} / \Delta V_{IO}$)	$V_{DD} = 4.4\ \text{V to } 16\ \text{V}, V_{IC} = V_{DD}/2, \text{ No load}$	25°C	80	95		80	95	dB	
		Full range	80			80			

† Full range is -40°C to 125°C for Q suffix, -55°C to 125°C for M suffix.

NOTE 4: Typical values are based on the input offset voltage shift observed through 500 hours of operating life test at $T_A = 150^\circ\text{C}$ extrapolated to $T_A = 25^\circ\text{C}$ using the Arrhenius equation and assuming an activation energy of 0.96 eV.



TLC2262Q/M electrical characteristics at specified free-air temperature, $V_{DD\pm} = \pm 5\text{ V}$ (unless otherwise noted) (continued)

PARAMETER	TEST CONDITIONS	T_A †	TLC2262Q, TLC2262M			TLC2262AQ, TLC2262AM			UNIT
			MIN	TYP	MAX	MIN	TYP	MAX	
I_{DD} Supply current	$V_O = 0$, No load	25°C	425		500	425		500	μA
		Full range			500			500	

† Full range is -40°C to 125°C for Q suffix, -55°C to 125°C for M suffix.

TLC2262Q/M operating characteristics at specified free-air temperature, $V_{DD\pm} = \pm 5\text{ V}$

PARAMETER	TEST CONDITIONS	T_A †	TLC2262Q, TLC2262M			TLC2262AQ, TLC2262AM			UNIT
			MIN	TYP	MAX	MIN	TYP	MAX	
SR Slew rate at unity gain	$V_O = \pm 2\text{ V}$, $C_L = 100\text{ pF}$, $R_L = 50\text{ k}\Omega$	25°C	0.35	0.55		0.35	0.55		$\text{V}/\mu\text{s}$
		Full range	0.25			0.25			
V_n Equivalent input noise voltage	$f = 10\text{ Hz}$ $f = 1\text{ kHz}$	25°C	43			43			$\text{nV}/\sqrt{\text{Hz}}$
		25°C	12			12			
$V_{N(PP)}$ Peak-to-peak equivalent input noise voltage	$f = 0.1\text{ Hz to }1\text{ Hz}$ $f = 0.1\text{ Hz to }10\text{ Hz}$	25°C	0.8			0.8			μV
		25°C	1.3			1.3			
I_n Equivalent input noise current		25°C	0.6			0.6			$\text{fA}/\sqrt{\text{Hz}}$
THD + N Total harmonic distortion plus noise	$V_O = \pm 2.3\text{ V}$, $R_L = 50\text{ k}\Omega$, $f = 20\text{ kHz}$	25°C	$A_V = 1$		0.014%		0.014%		
			$A_V = 10$		0.024%		0.024%		
Gain-bandwidth product	$f = 10\text{ kHz}$, $C_L = 100\text{ pF}$, $R_L = 50\text{ k}\Omega$	25°C	0.73			0.73			MHz
B_{OM} Maximum output-swing bandwidth	$V_{O(PP)} = 4.6\text{ V}$, $R_L = 50\text{ k}\Omega$, $A_V = 1$, $C_L = 100\text{ pF}$	25°C	85			85			kHz
t_s Settling time	$A_V = -1$, Step = $-2.3\text{ V to }2.3\text{ V}$, $R_L = 50\text{ k}\Omega$, $C_L = 100\text{ pF}$	25°C	To 0.1%		7.1		7.1		μs
			To 0.01%		16.5		16.5		
ϕ_m Phase margin at unity gain	$R_L = 50\text{ k}\Omega$, $C_L = 100\text{ pF}$	25°C	57°			57°			
		25°C	11			11			

† Full range is -40°C to 125°C for Q suffix, -55°C to 125°C for M suffix.

TLC226x, TLC226xA
Advanced LinCMOS™ RAIL-TO-RAIL
OPERATIONAL AMPLIFIERS

SLOS177A – FEBRUARY 1997 – REVISED JULY 1999

TLC2264Q/M electrical characteristics at specified free-air temperature, $V_{DD} = 5\text{ V}$ (unless otherwise noted)

PARAMETER	TEST CONDITIONS	T_A †	TLC2264Q, TLC2264M			TLC2264AQ, TLC2264AM			UNIT	
			MIN	TYP	MAX	MIN	TYP	MAX		
V_{IO} Input offset voltage		25°C	300	2500		300	950	μV		
		Full range			3000		1500			
α_{VIO} Temperature coefficient of input offset voltage		Full range	2			2			$\mu\text{V}/^\circ\text{C}$	
Input offset voltage long-term drift (see Note 4)	$V_{DD\pm} = \pm 2.5\text{ V}$, $V_O = 0$, $V_{IC} = 0$, $R_S = 50\ \Omega$	25°C	0.003			0.003			$\mu\text{V}/\text{mo}$	
I_{IO} Input offset current		25°C	0.5			0.5			pA	
		125°C	500			500				
I_{IB} Input bias current		25°C	1			1			pA	
	125°C	500			500					
V_{ICR} Common-mode input voltage range	$R_S = 50\ \Omega$, $ V_{IO} \leq 5\text{ mV}$	25°C	0 to 4	-0.3 to 4.2		0 to 4	-0.3 to 4.2	V		
		Full range	0 to 3.5			0 to 3.5				
V_{OH} High-level output voltage	$I_{OH} = -20\ \mu\text{A}$	25°C	4.99			4.99			V	
		Full range	4.82			4.82				
	$I_{OH} = -100\ \mu\text{A}$	25°C	4.7	4.85		4.7	4.85			
		Full range	4.5			4.5				
V_{OL} Low-level output voltage	$V_{IC} = 2.5\text{ V}$, $I_{OL} = 50\ \mu\text{A}$	25°C	0.01			0.01			V	
		Full range	0.09 to 0.15			0.09 to 0.15				
	$V_{IC} = 2.5\text{ V}$, $I_{OL} = 500\ \mu\text{A}$	25°C	0.8			0.7				
		Full range	1.2			1.2				
A_{VD} Large-signal differential voltage amplification	$V_{IC} = 2.5\text{ V}$, $V_O = 1\text{ V to }4\text{ V}$	$R_L = 50\ \text{k}\Omega$ ‡	25°C	80	100		80	170		V/mV
			Full range	50			50			
		$R_L = 1\ \text{M}\Omega$ ‡	25°C	550			550			
$r_{i(d)}$ Differential input resistance		25°C	10^{12}			10^{12}			Ω	
$r_{i(c)}$ Common-mode input resistance		25°C	10^{12}			10^{12}			Ω	
$C_{i(c)}$ Common-mode input capacitance	$f = 10\ \text{kHz}$, N package	25°C	8			8			pF	
Z_o Closed-loop output impedance	$f = 100\ \text{kHz}$, $A_V = 10$	25°C	240			240			Ω	
CMRR Common-mode rejection ratio	$V_{IC} = 0\text{ to }2.7\text{ V}$, $V_O = 2.5\text{ V}$, $R_S = 50\ \Omega$	25°C	70	83		70	83		dB	
		Full range	70			70				
k_{SVR} Supply-voltage rejection ratio ($\Delta V_{DD}/\Delta V_{IO}$)	$V_{DD} = 4.4\text{ V to }16\text{ V}$, $V_{IC} = V_{DD}/2$, No load	25°C	80	95		80	95		dB	
		Full range	80			80				

† Full range is -40°C to 125°C for Q suffix, -55°C to 125°C for M suffix.

‡ Referenced to 2.5 V

NOTE 4: Typical values are based on the input offset voltage shift observed through 500 hours of operating life test at $T_A = 150^\circ\text{C}$ extrapolated to $T_A = 25^\circ\text{C}$ using the Arrhenius equation and assuming an activation energy of 0.96 eV.



TLC226x, TLC226xA
Advanced LinCMOS™ RAIL-TO-RAIL
OPERATIONAL AMPLIFIERS

SLOS177A – FEBRUARY 1997 – REVISED JULY 1999

TLC2264Q/M electrical characteristics at specified free-air temperature, $V_{DD} = 5\text{ V}$ (unless otherwise noted) (continued)

PARAMETER	TEST CONDITIONS	T_A †	TLC2264Q, TLC2264M			TLC2264AQ, TLC2264AM			UNIT
			MIN	TYP	MAX	MIN	TYP	MAX	
I_{DD}	Supply current (four amplifiers)	$V_O = 2.5\text{ V}$, No load	25°C	0.8	1	0.8	1	mA	
			Full range		1		1		

† Full range is -40°C to 125°C for Q suffix, -55°C to 125°C for M suffix.

TLC2264Q/M operating characteristics at specified free-air temperature, $V_{DD} = 5\text{ V}$

PARAMETER	TEST CONDITIONS	T_A †	TLC2264Q, TLC2264M			TLC2264AQ, TLC2264AM			UNIT		
			MIN	TYP	MAX	MIN	TYP	MAX			
SR	Slew rate at unity gain	$V_O = 0.5\text{ V}$ to 3.5 V , $C_L = 100\text{ pF}$ ‡	$R_L = 50\text{ k}\Omega$ ‡	25°C	0.35	0.55	0.35	0.55	V/ μs		
				Full range	0.25		0.25				
V_n	Equivalent input noise voltage	$f = 10\text{ Hz}$	25°C	40			40			nV/ $\sqrt{\text{Hz}}$	
				$f = 1\text{ kHz}$	12			12			
$V_N(\text{PP})$	Peak-to-peak equivalent input noise voltage	$f = 0.1\text{ Hz}$ to 1 Hz	25°C	0.7			0.7			μV	
		$f = 0.1\text{ Hz}$ to 10 Hz	25°C	1.3			1.3				
I_n	Equivalent input noise current		25°C	0.6			0.6			fA/ $\sqrt{\text{Hz}}$	
THD + N	Total harmonic distortion plus noise	$V_O = 0.5\text{ V}$ to 2.5 V , $f = 20\text{ kHz}$, $R_L = 50\text{ k}\Omega$ ‡	$A_V = 1$	25°C	0.017%			0.017%			
			$A_V = 10$		0.03%			0.03%			
	Gain-bandwidth product	$f = 50\text{ kHz}$, $C_L = 100\text{ pF}$ ‡	$R_L = 50\text{ k}\Omega$ ‡	25°C	0.71			0.71			MHz
B_{OM}	Maximum output-swing bandwidth	$V_O(\text{PP}) = 2\text{ V}$, $R_L = 50\text{ k}\Omega$ ‡	$A_V = 1$, $C_L = 100\text{ pF}$ ‡	25°C	185			185			kHz
t_s	Settling time	$A_V = -1$, Step = 0.5 V to 2.5 V , $R_L = 50\text{ k}\Omega$ ‡, $C_L = 100\text{ pF}$ ‡	To 0.1%	25°C	6.4			6.4			μs
			To 0.01%		14.1			14.1			
ϕ_m	Phase margin at unity gain	$R_L = 50\text{ k}\Omega$ ‡	$C_L = 100\text{ pF}$ ‡	25°C	56°			56°			
	Gain margin			25°C	11			11			

† Full range is -40°C to 125°C for Q suffix, -55°C to 125°C for M suffix.

‡ Referenced to 2.5 V

TLC226x, TLC226xA Advanced LinCMOS™ RAIL-TO-RAIL OPERATIONAL AMPLIFIERS

SLOS177A – FEBRUARY 1997 – REVISED JULY 1999

TLC2264Q/M electrical characteristics at specified free-air temperature, $V_{DD\pm} = \pm 5\text{ V}$ (unless otherwise noted)

PARAMETER	TEST CONDITIONS	T_A †	TLC2264Q, TLC2264M			TLC2264AQ, TLC2264AM			UNIT
			MIN	TYP	MAX	MIN	TYP	MAX	
V_{IO} Input offset voltage	$V_{IC} = 0,$ $R_S = 50\ \Omega$ $V_O = 0,$	25°C	300	2500		300	950	μV	
		Full range		3000		1500			
α_{VIO} Temperature coefficient of input offset voltage		Full range		2		2		$\mu\text{V}/^\circ\text{C}$	
Input offset voltage long-term drift (see Note 4)		25°C		0.003		0.003		$\mu\text{V}/\text{mo}$	
I_{IO} Input offset current		25°C		0.5		0.5		pA	
		125°C		500		500			
I_{IB} Input bias current	25°C		1		1		pA		
	125°C		500		500				
V_{ICR} Common-mode input voltage range	$R_S = 50\ \Omega,$ $ V_{IO} \leq 5\ \text{mV}$	25°C	-5 to 4	-5.3 to 4.2		-5 to 4	-5.3 to 4.2	V	
		Full range	-5 to 3.5			-5 to 3.5			
V_{OM+} Maximum positive peak output voltage	$I_O = -20\ \mu\text{A}$ $I_O = -100\ \mu\text{A}$ $I_O = -400\ \mu\text{A}$	25°C		4.99		4.99		V	
		25°C	4.85	4.94		4.85	4.94		
		Full range	4.82			4.82			
		25°C	4.7	4.85		4.7	4.85		
V_{OM-} Maximum negative peak output voltage	$V_{IC} = 0,$ $I_O = 50\ \mu\text{A}$ $V_{IC} = 0,$ $I_O = 500\ \mu\text{A}$ $V_{IC} = 0,$ $I_O = 4\ \text{mA}$	25°C		-4.99		-4.99		V	
		25°C	-4.85	-4.91		-4.85	-4.91		
		Full range	-4.85			-4.85			
		25°C	-4	-4.3		-4	-4.3		
A_{VD} Large-signal differential voltage amplification	$V_O = \pm 4\ \text{V}$	$R_L = 50\ \text{k}\Omega$	25°C	80	200		80	200	V/mV
			Full range	50			50		
		$R_L = 1\ \text{M}\Omega$	25°C		1000		1000		
$r_{i(d)}$ Differential input resistance		25°C		10^{12}		10^{12}		Ω	
$r_{i(c)}$ Common-mode input resistance		25°C		10^{12}		10^{12}		Ω	
$c_{i(c)}$ Common-mode input capacitance	$f = 10\ \text{kHz},$ N package	25°C		8		8		pF	
z_o Closed-loop output impedance	$f = 100\ \text{kHz},$ $A_V = 10$	25°C		220		220		Ω	
CMRR Common-mode rejection ratio	$V_{IC} = -5\ \text{V to } 2.7\ \text{V},$ $V_O = 0,$ $R_S = 50\ \Omega$	25°C	75	88		75	88	dB	
		Full range	75			75			
k_{SVR} Supply-voltage rejection ratio ($\Delta V_{DD\pm}/\Delta V_{IO}$)	$V_{DD\pm} = \pm 2.2\ \text{V to } \pm 8\ \text{V},$ $V_{IC} = V_{DD}/2,$ No load	25°C	80	95		80	95	dB	
		Full range	80			80			

† Full range is -40°C to 125°C for Q suffix, -55°C to 125°C for M suffix.

NOTE 4: Typical values are based on the input offset voltage shift observed through 500 hours of operating life test at $T_A = 150^\circ\text{C}$ extrapolated to $T_A = 25^\circ\text{C}$ using the Arrhenius equation and assuming an activation energy of 0.96 eV.



TLC2264Q/M electrical characteristics at specified free-air temperature, $V_{DD\pm} = \pm 5\text{ V}$ (unless otherwise noted) (continued)

PARAMETER	TEST CONDITIONS	T_A †	TLC2264Q, TLC2264M			TLC2264AQ, TLC2264AM			UNIT
			MIN	TYP	MAX	MIN	TYP	MAX	
I_{DD}	Supply current (four amplifiers)	$V_O = 0,$ No load	25°C	0.85	1	0.85	1	mA	
			Full range		1		1		

† Full range is -40°C to 125°C for Q suffix, -55°C to 125°C for M suffix.

TLC2264Q/M operating characteristics at specified free-air temperature, $V_{DD\pm} = \pm 5\text{ V}$

PARAMETER	TEST CONDITIONS	T_A †	TLC2264Q, TLC2264M			TLC2264AQ, TLC2264AM			UNIT
			MIN	TYP	MAX	MIN	TYP	MAX	
SR	Slew rate at unity gain $V_O = \pm 2\text{ V},$ $C_L = 100\text{ pF}$ $R_L = 50\text{ k}\Omega,$	25°C	0.35	0.55		0.35	0.55	V/ μs	
		Full range	0.25			0.25			
V_n	Equivalent input noise voltage	25°C	43			43			nV/ $\sqrt{\text{Hz}}$
		25°C	12			12			
$V_{N(PP)}$	Peak-to-peak equivalent input noise voltage	25°C	0.8			0.8			μV
		25°C	1.3			1.3			
I_n	Equivalent input noise current	25°C	0.6			0.6			fA/ $\sqrt{\text{Hz}}$
THD + N	Total harmonic distortion plus noise $V_O = \pm 2.3\text{ V},$ $R_L = 50\text{ k}\Omega,$ $f = 20\text{ kHz}$	25°C	$A_V = 1$			0.014%			
			$A_V = 10$			0.024%			
	Gain-bandwidth product $f = 10\text{ kHz},$ $C_L = 100\text{ pF}$ $R_L = 50\text{ k}\Omega,$	25°C	0.73			0.73			MHz
BOM	Maximum output-swing bandwidth $V_O(PP) = 4.6\text{ V},$ $R_L = 50\text{ k}\Omega,$ $A_V = 1,$ $C_L = 100\text{ pF}$	25°C	70			70			kHz
t_s	Settling time $A_V = -1,$ Step = -2.3 V to $2.3\text{ V},$ $R_L = 50\text{ k}\Omega,$ $C_L = 100\text{ pF}$	25°C	To 0.1%			7.1			μs
			To 0.01%			16.5			
ϕ_m	Phase margin at unity gain $R_L = 50\text{ k}\Omega,$ $C_L = 100\text{ pF}$	25°C	57°			57°			
		25°C	11			11			

† Full range is -40°C to 125°C for Q suffix, -55°C to 125°C for M suffix.

TLC226x, TLC226xA
Advanced LinCMOS™ RAIL-TO-RAIL
OPERATIONAL AMPLIFIERS

SLOS177A – FEBRUARY 1997 – REVISED JULY 1999

TYPICAL CHARACTERISTICS

Table of Graphs

			FIGURE
V_{IO}	Input offset voltage	Distribution vs Common-mode input voltage	2 – 5 6, 7
α_{VIO}	Input offset voltage temperature coefficient	Distribution	8 – 11
I_{IB}/I_{IO}	Input bias and input offset currents	vs Free-air temperature	12
V_I	Input voltage range	vs Supply voltage vs Free-air temperature	13 14
V_{OH}	High-level output voltage	vs High-level output current	15
V_{OL}	Low-level output voltage	vs Low-level output current	16, 17
V_{OM+}	Maximum positive peak output voltage	vs Output current	18
V_{OM-}	Maximum negative peak output voltage	vs Output current	19
$V_{O(PP)}$	Maximum peak-to-peak output voltage	vs Frequency	20
I_{OS}	Short-circuit output current	vs Supply voltage vs Free-air temperature	21 22
V_O	Output voltage	vs Differential input voltage	23, 24
	Differential gain	vs Load resistance	25
A_{VD}	Large-signal differential voltage amplification	vs Frequency vs Free-air temperature	26, 27 28, 29
z_o	Output impedance	vs Frequency	30, 31
CMRR	Common-mode rejection ratio	vs Frequency vs Free-air temperature	32 33
k_{SVR}	Supply-voltage rejection ratio	vs Frequency vs Free-air temperature	34, 35 36
I_{DD}	Supply current	vs Supply voltage vs Free-air temperature	37, 38 39, 40
SR	Slew rate	vs Load capacitance vs Free-air temperature	41 42
V_O	Inverting large-signal pulse response		43, 44
	Voltage-follower large-signal pulse response		45, 46
	Inverting small-signal pulse response		47, 48
	Voltage-follower small-signal pulse response		49, 50
V_n	Equivalent input noise voltage	vs Frequency	51, 52
	Noise voltage (referred to input)	Over a 10-second period	53
	Integrated noise voltage	vs Frequency	54
THD + N	Total harmonic distortion plus noise	vs Frequency	55
	Gain-bandwidth product	vs Supply voltage vs Free-air temperature	56 57
ϕ_m	Phase margin	vs Frequency vs Load capacitance	26, 27 58
	Gain margin	vs Load capacitance	59
B_1	Unity-gain bandwidth	vs Load capacitance	60
	Overestimation of phase margin	vs Load capacitance	61



TYPICAL CHARACTERISTICS

DISTRIBUTION OF TLC2262
 INPUT OFFSET VOLTAGE

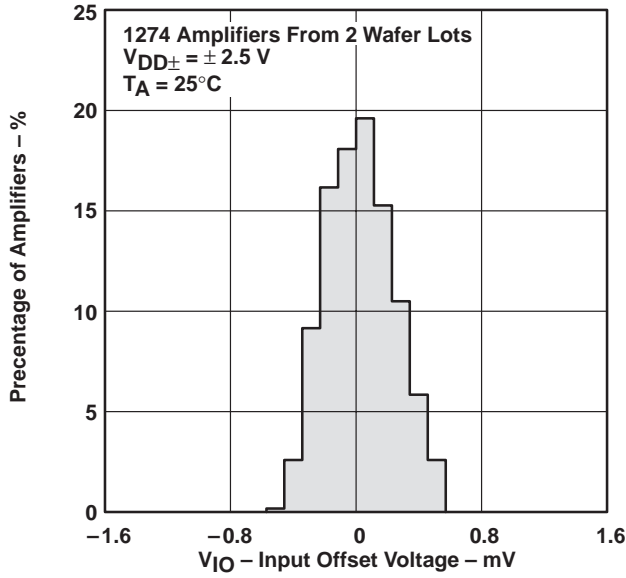

Figure 2

DISTRIBUTION OF TLC2262
 INPUT OFFSET VOLTAGE

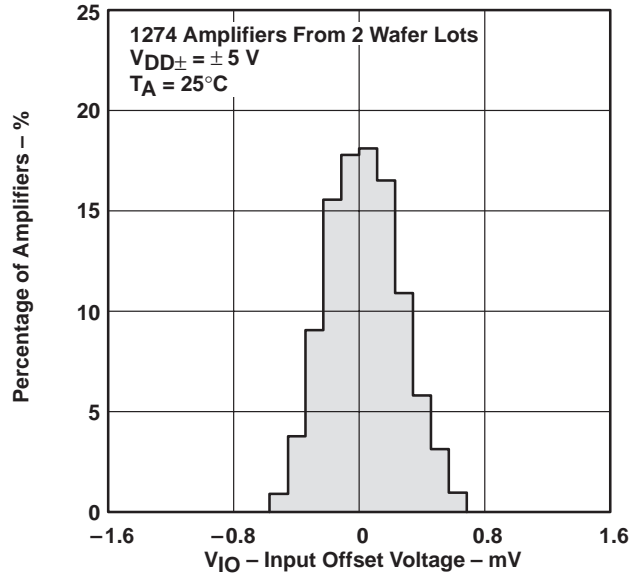

Figure 3

DISTRIBUTION OF TLC2264
 INPUT OFFSET VOLTAGE

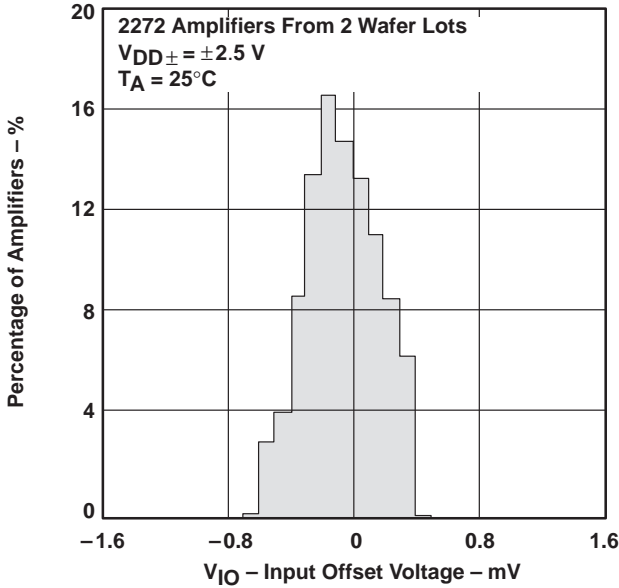

Figure 4

DISTRIBUTION OF TLC2264
 INPUT OFFSET VOLTAGE

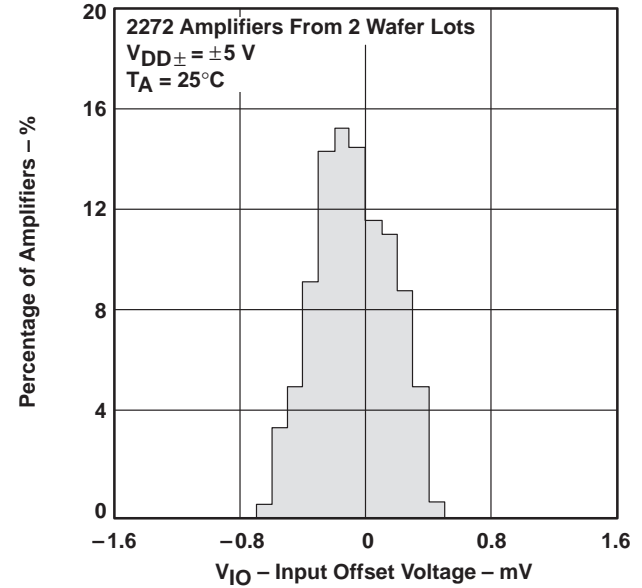

Figure 5

TYPICAL CHARACTERISTICS

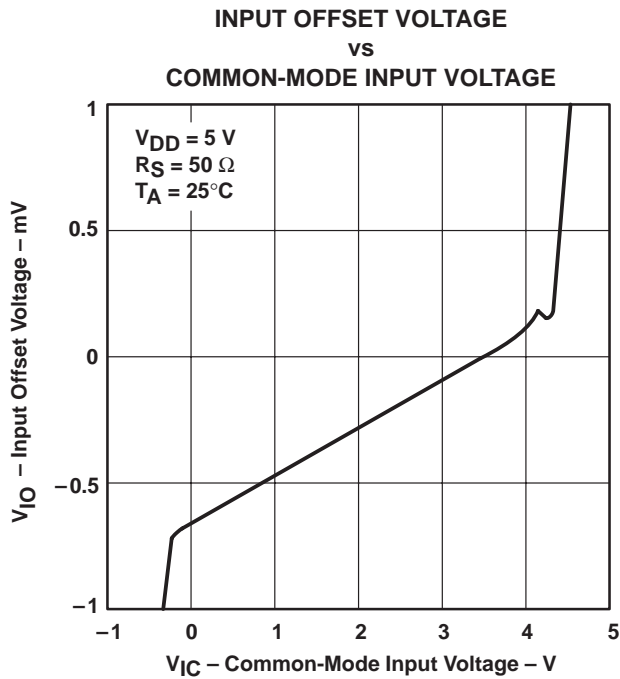

Figure 6

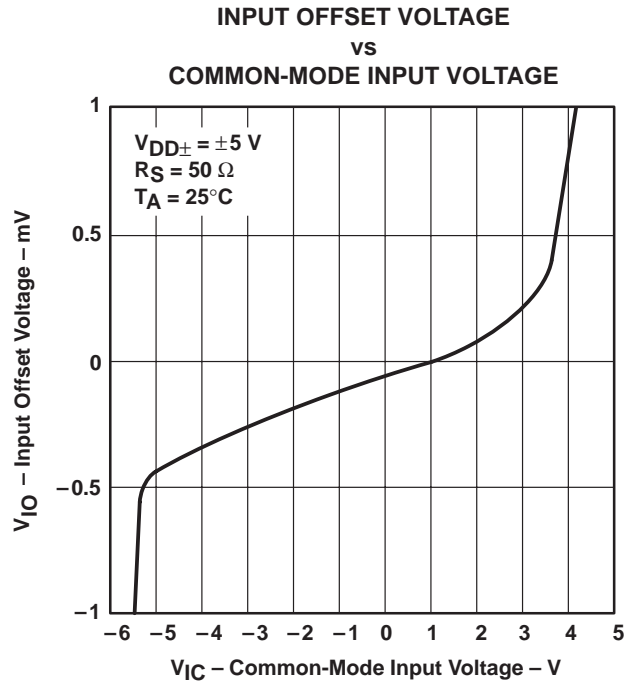

Figure 7

† For curves where $V_{DD} = 5\text{ V}$, all loads are referenced to 2.5 V.

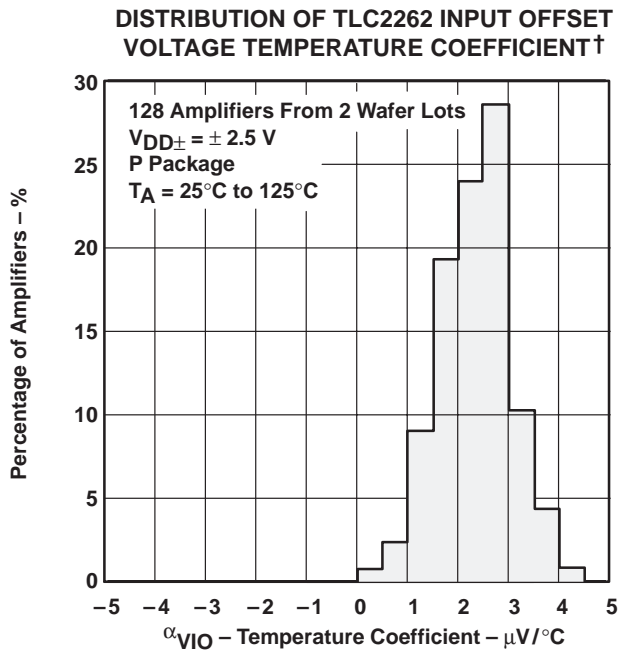

Figure 8

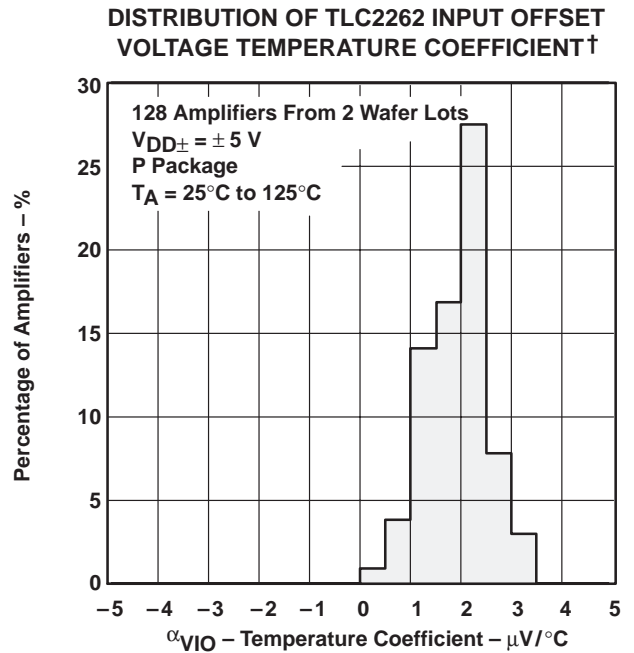

Figure 9

† Data at high and low temperatures are applicable only within the rated operating free-air temperature ranges of the various devices.

TYPICAL CHARACTERISTICS

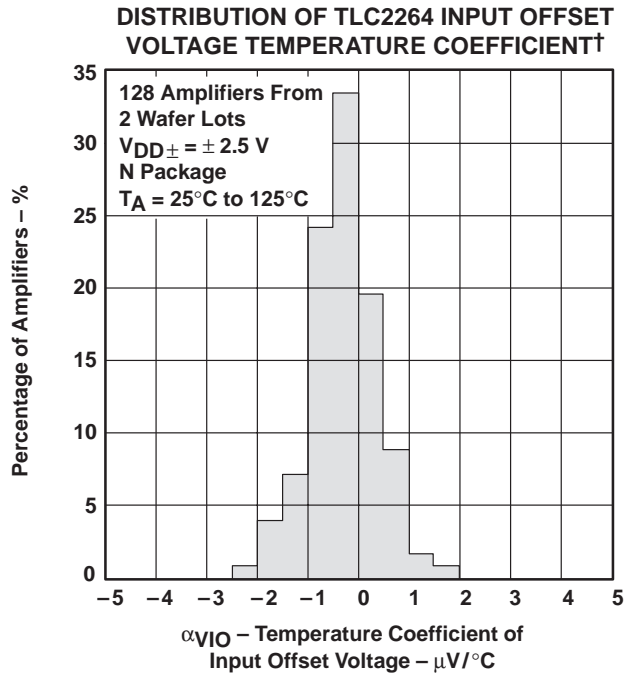

Figure 10

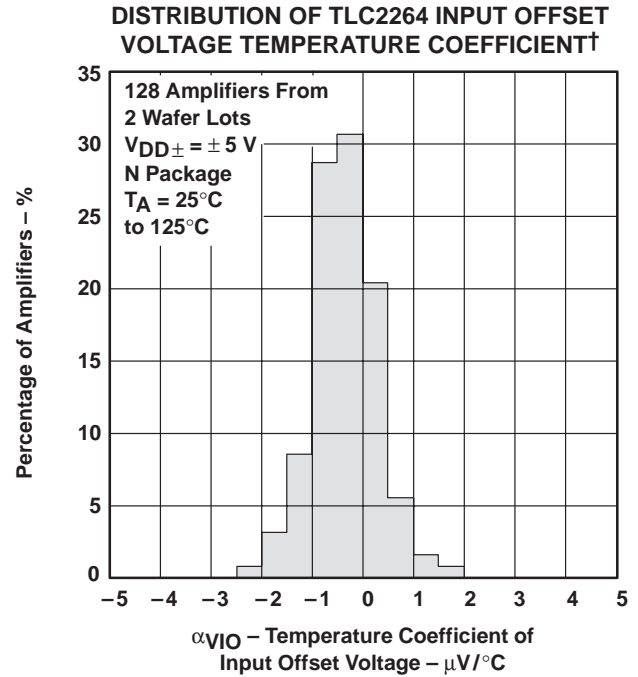

Figure 11

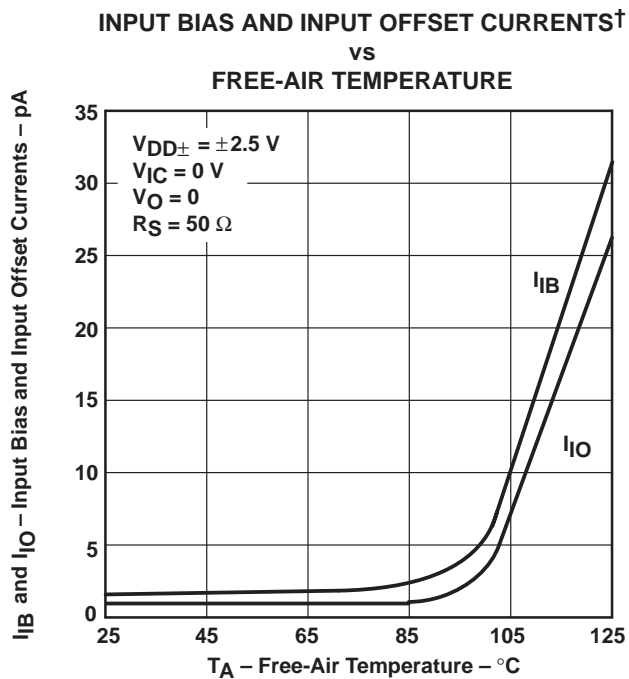

Figure 12

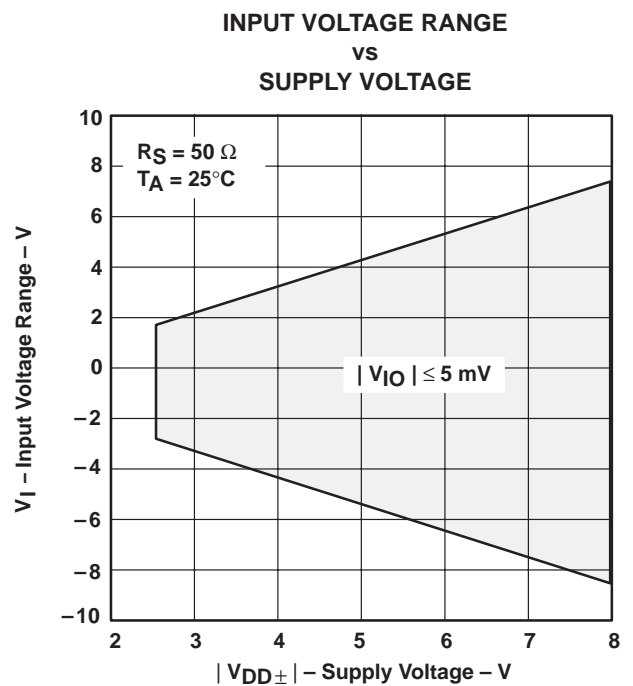

Figure 13

† Data at high and low temperatures are applicable only within the rated operating free-air temperature ranges of the various devices.

TYPICAL CHARACTERISTICS

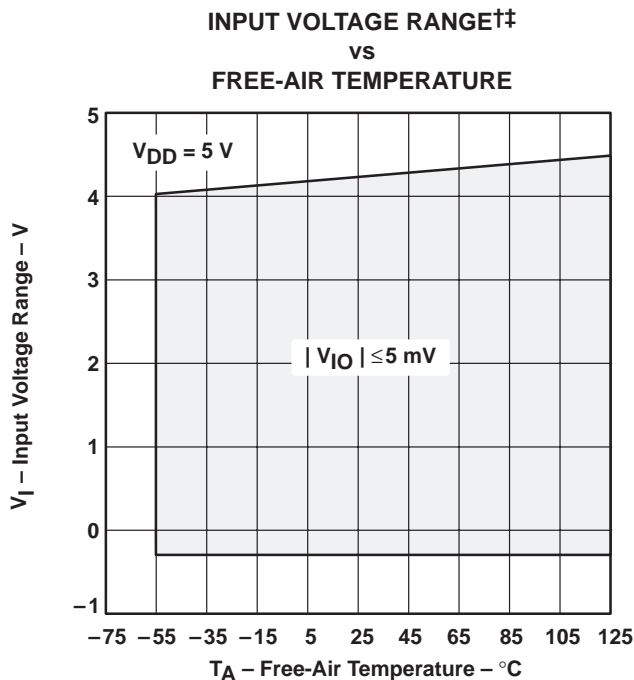

Figure 14

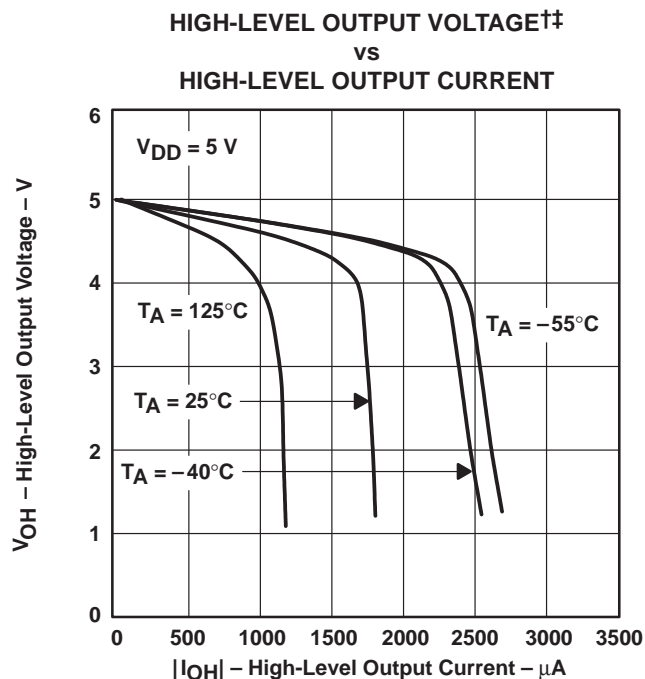

Figure 15

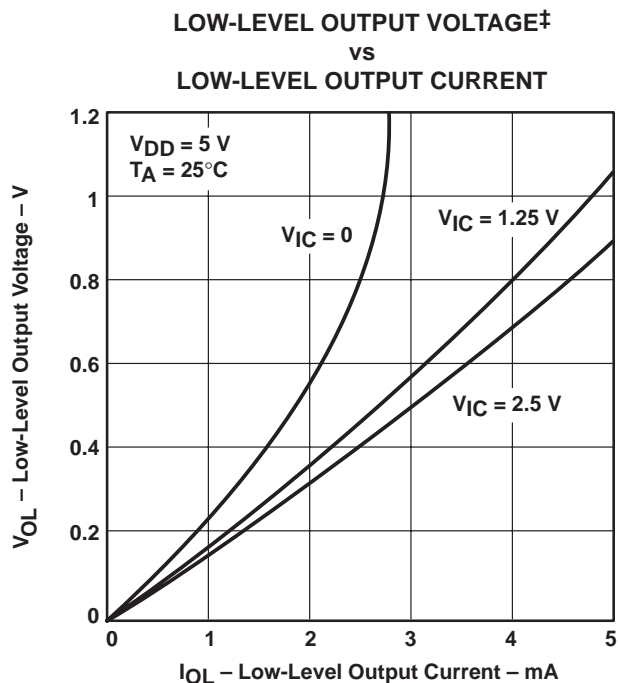

Figure 16

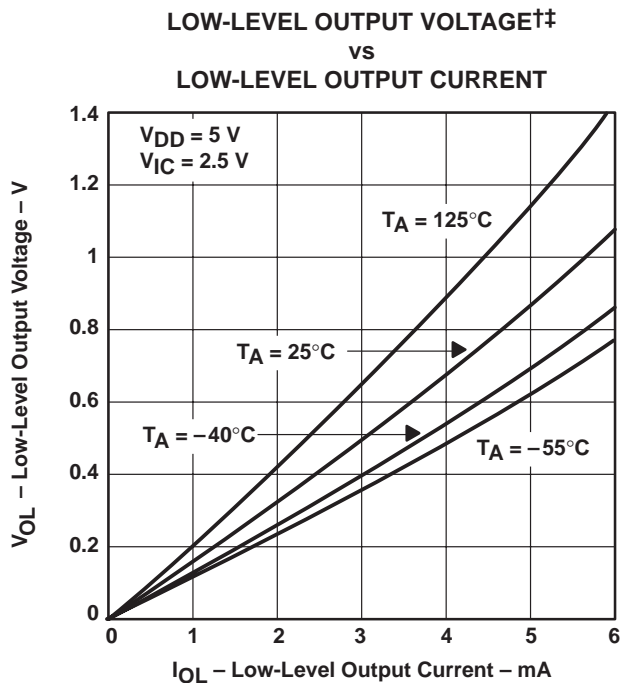

Figure 17

† Data at high and low temperatures are applicable only within the rated operating free-air temperature ranges of the various devices.

‡ For curves where $V_{DD} = 5\text{ V}$, all loads are referenced to 2.5 V.

TYPICAL CHARACTERISTICS

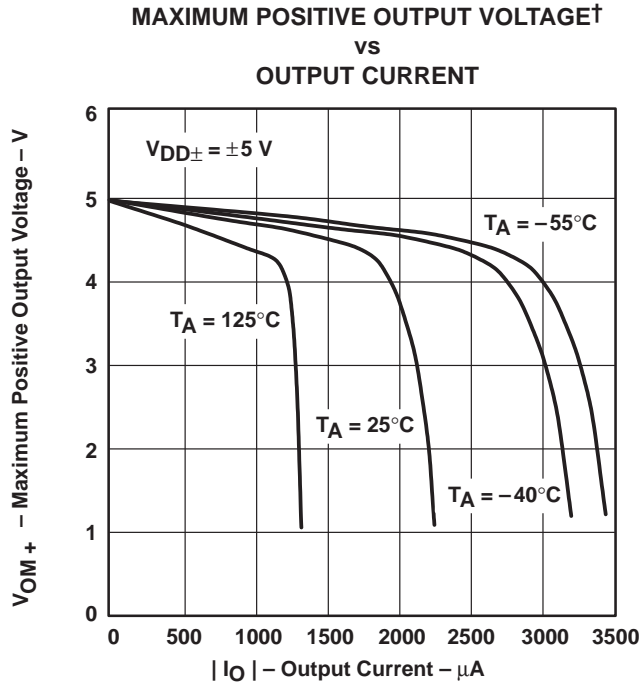

Figure 18

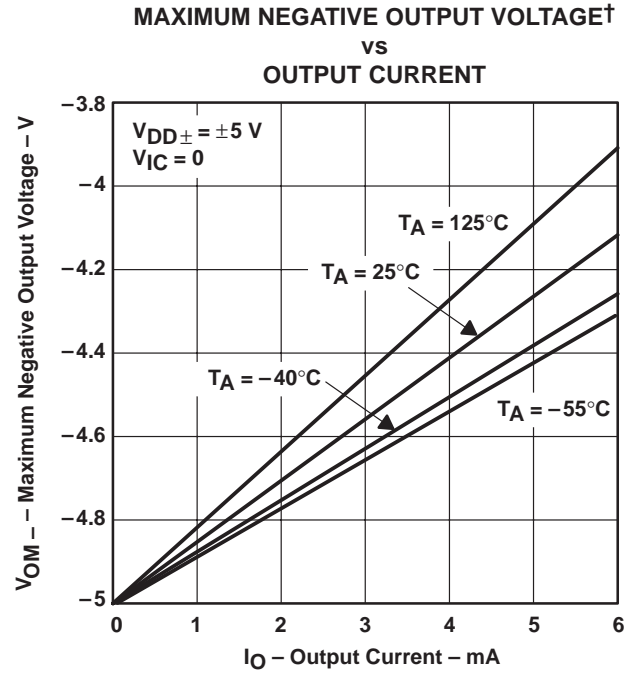

Figure 19

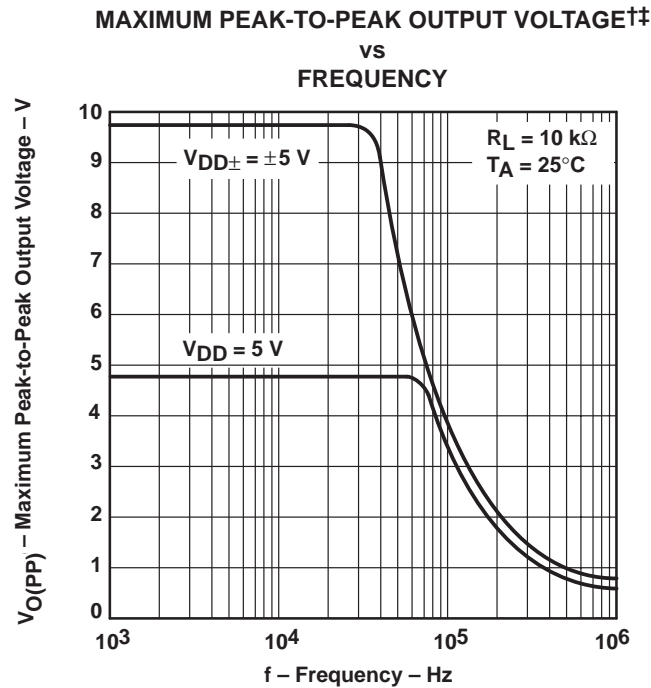

Figure 20

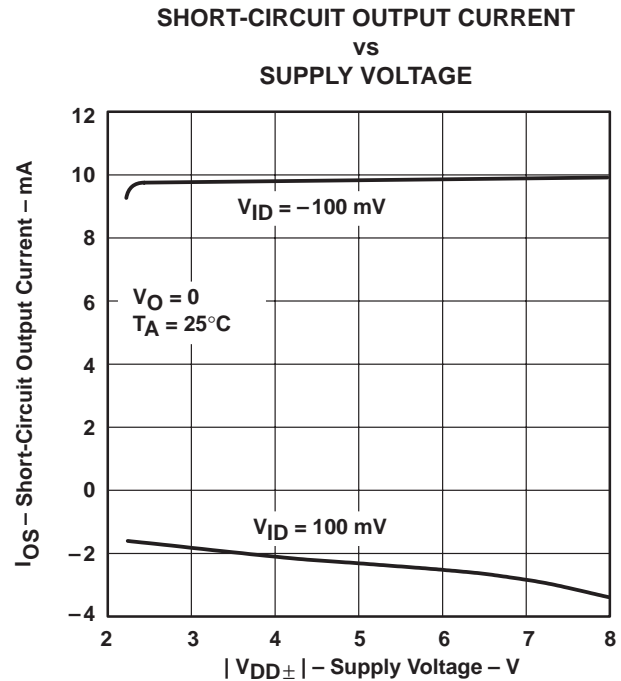

Figure 21

‡ For curves where $V_{DD} = 5 \text{ V}$, all loads are referenced to 2.5 V.

† Data at high and low temperatures are applicable only within the rated operating free-air temperature ranges of the various devices.

TYPICAL CHARACTERISTICS

SHORT-CIRCUIT OUTPUT CURRENT †
 vs
 FREE-AIR TEMPERATURE

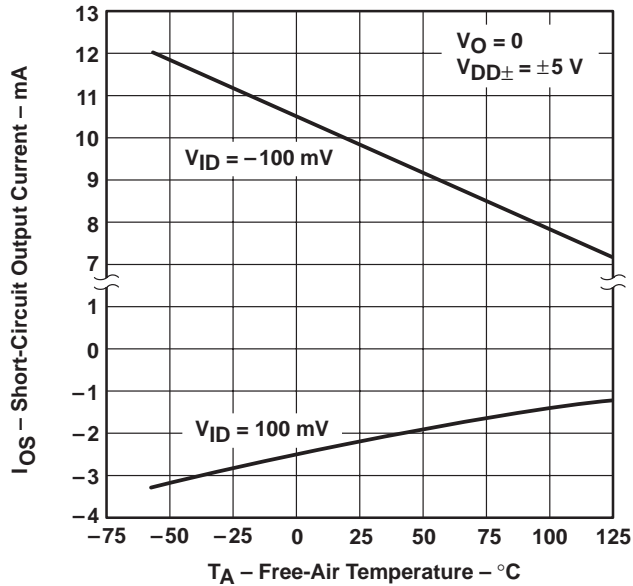

Figure 22

OUTPUT VOLTAGE ‡
 vs
 DIFFERENTIAL INPUT VOLTAGE

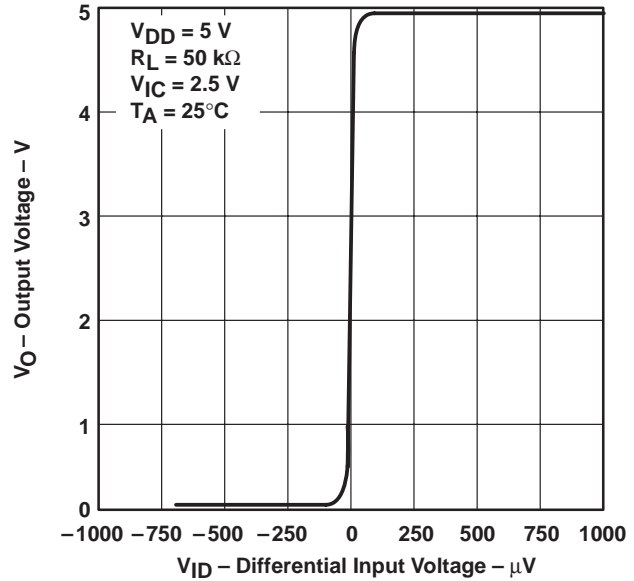

Figure 23

OUTPUT VOLTAGE
 vs
 DIFFERENTIAL INPUT VOLTAGE

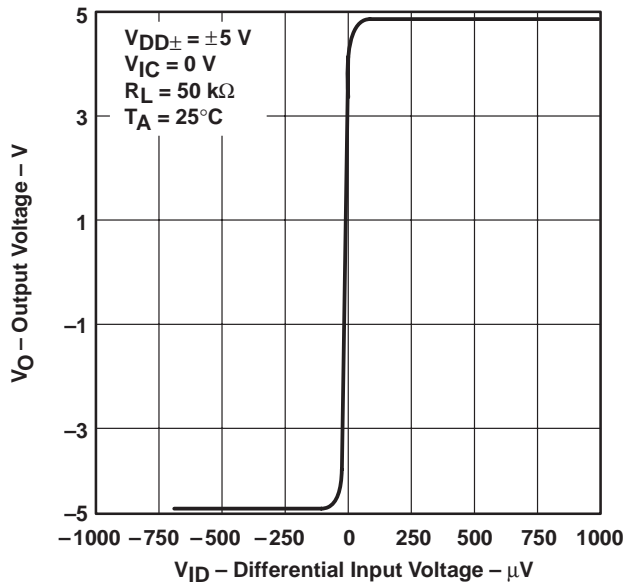

Figure 24

DIFFERENTIAL GAIN ‡
 vs
 LOAD RESISTANCE

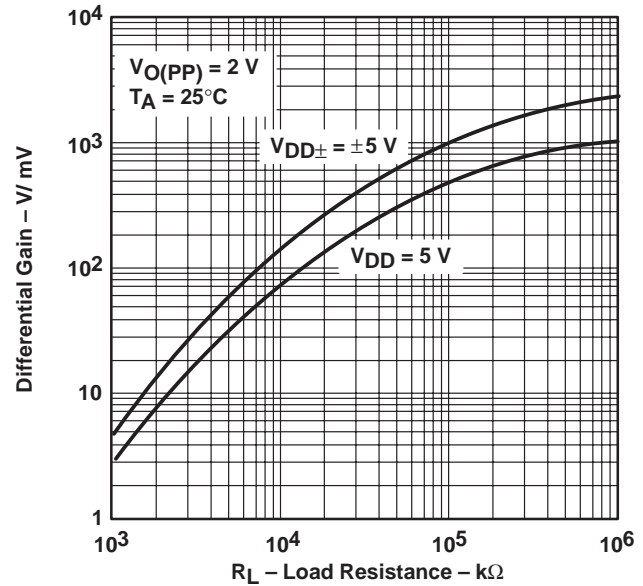

Figure 25

† Data at high and low temperatures are applicable only within the rated operating free-air temperature ranges of the various devices.

‡ For curves where $V_{DD} = 5\text{ V}$, all loads are referenced to 2.5 V.

TYPICAL CHARACTERISTICS

LARGE-SIGNAL DIFFERENTIAL VOLTAGE†
 AMPLIFICATION AND PHASE MARGIN
 VS
 FREQUENCY

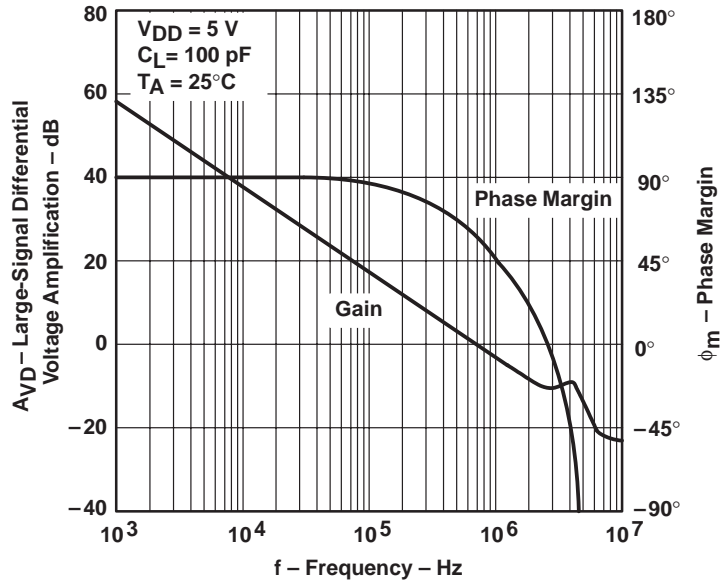

† For curves where V_{DD} = 5 V, all loads are referenced to 2.5 V.

Figure 26

LARGE-SIGNAL DIFFERENTIAL VOLTAGE
 AMPLIFICATION AND PHASE MARGIN
 VS
 FREQUENCY

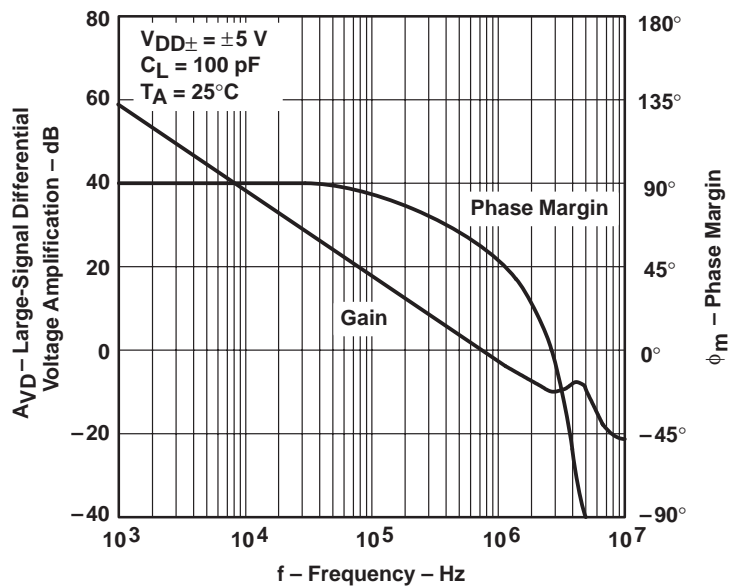

Figure 27

TYPICAL CHARACTERISTICS

LARGE-SIGNAL DIFFERENTIAL
 VOLTAGE AMPLIFICATION†‡
 vs
 FREE-AIR TEMPERATURE

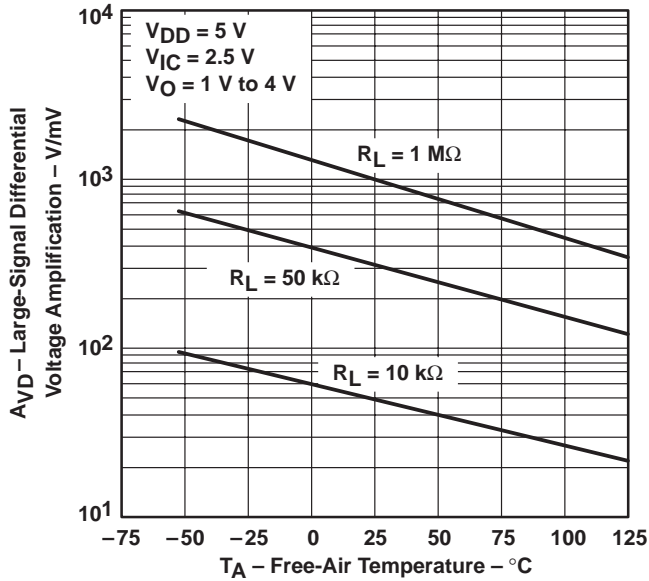

Figure 28

LARGE-SIGNAL DIFFERENTIAL
 VOLTAGE AMPLIFICATION†
 vs
 FREE-AIR TEMPERATURE

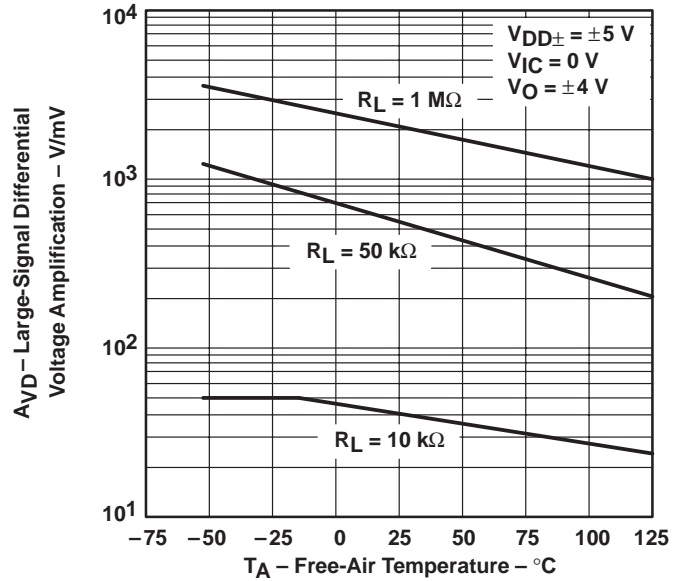

Figure 29

OUTPUT IMPEDANCE‡
 vs
 FREQUENCY

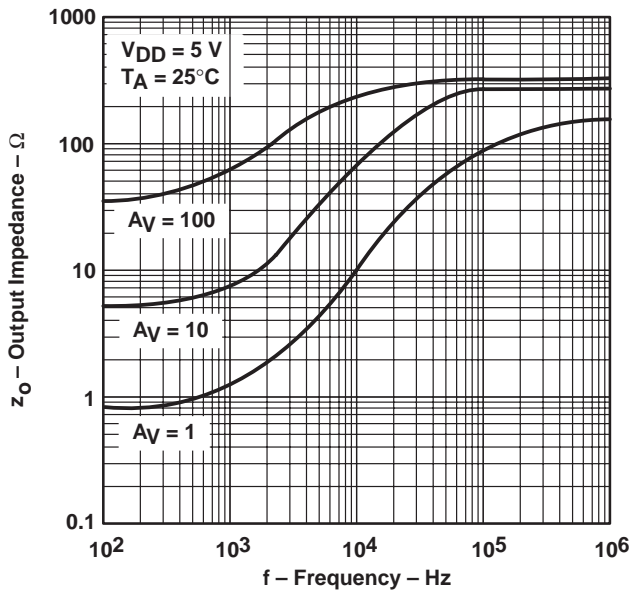

Figure 30

OUTPUT IMPEDANCE
 vs
 FREQUENCY

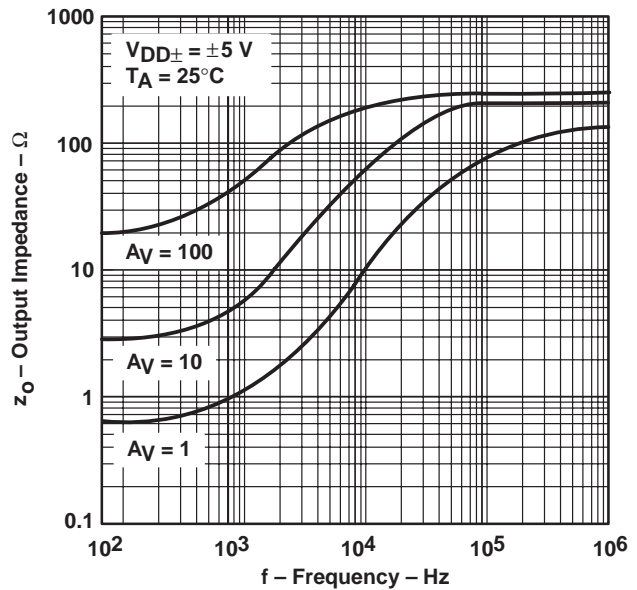

Figure 31

† Data at high and low temperatures are applicable only within the rated operating free-air temperature ranges of the various devices.

‡ For curves where $V_{DD} = 5\text{ V}$, all loads are referenced to 2.5 V.

TYPICAL CHARACTERISTICS

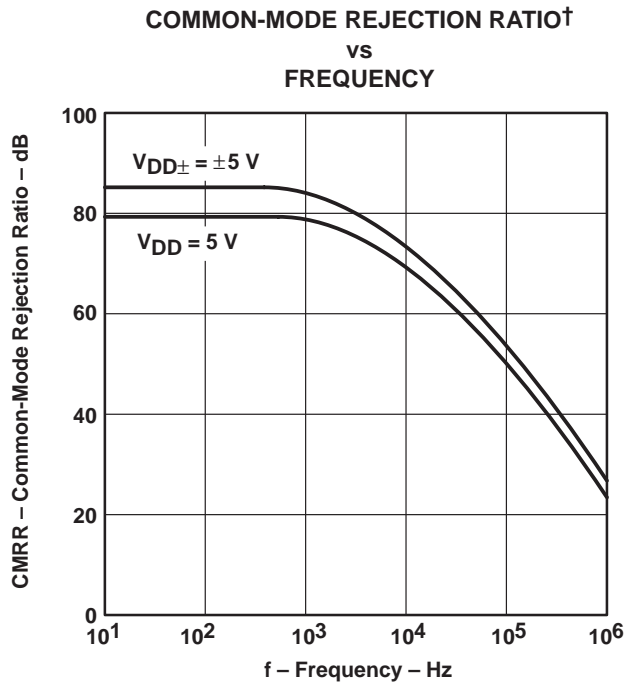

Figure 32

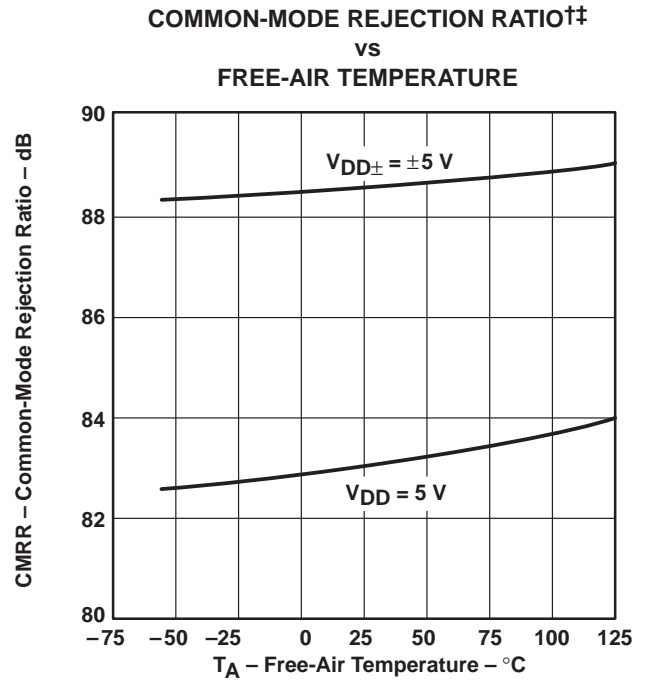

Figure 33

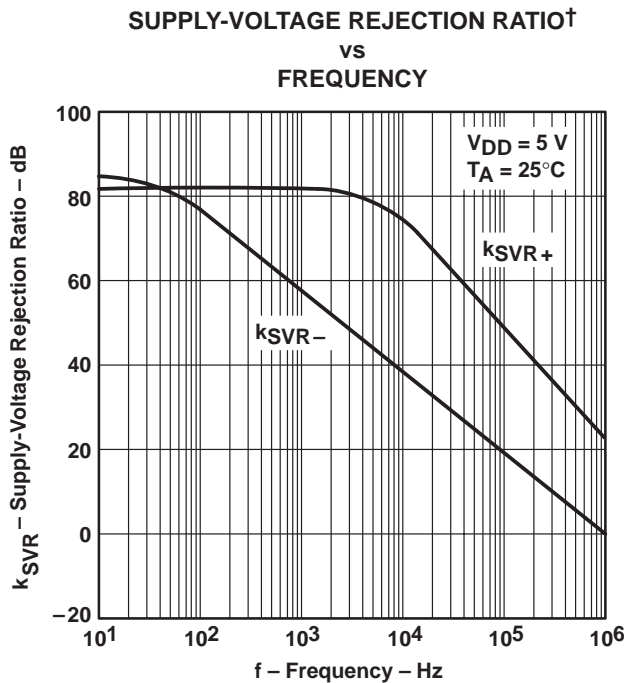

Figure 34

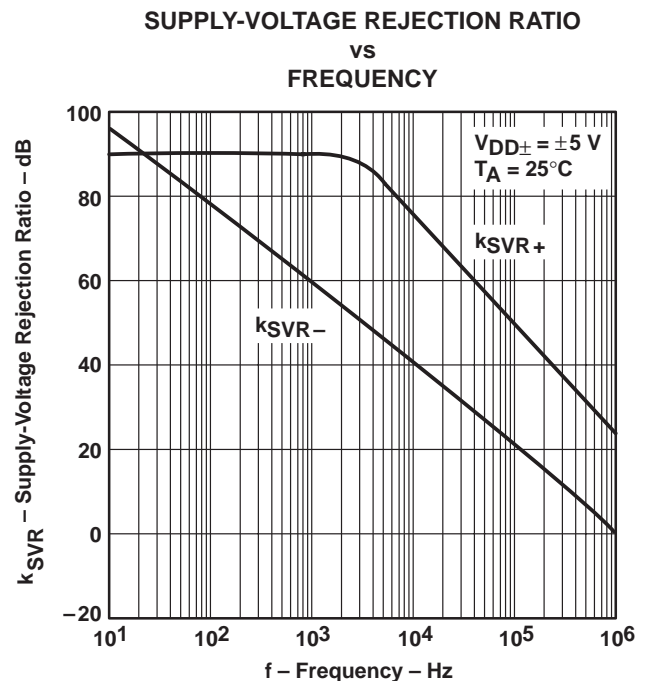

Figure 35

† For curves where $V_{DD} = 5\text{ V}$, all loads are referenced to 2.5 V .

‡ Data at high and low temperatures are applicable only within the rated operating free-air temperature ranges of the various devices.

TYPICAL CHARACTERISTICS

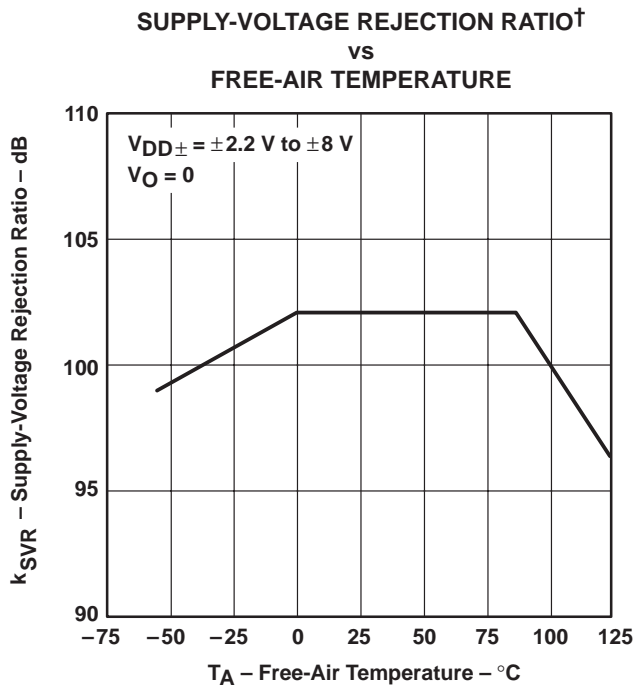

Figure 36

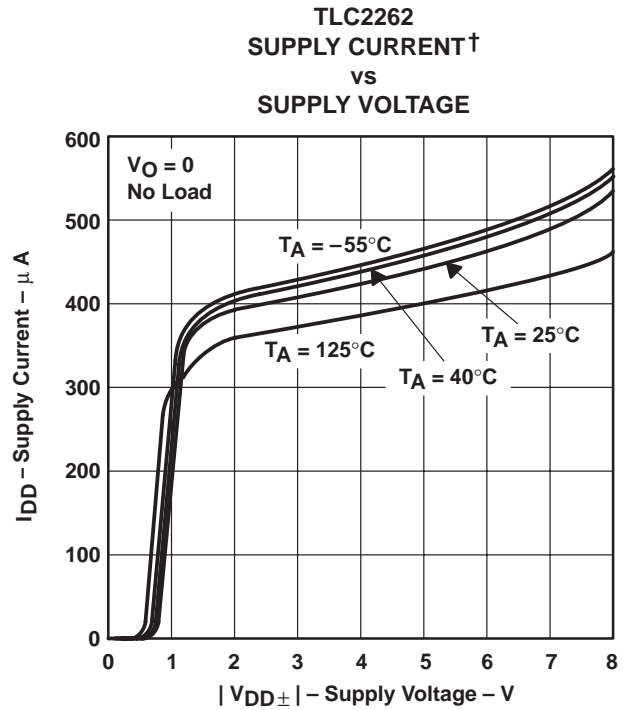

Figure 37

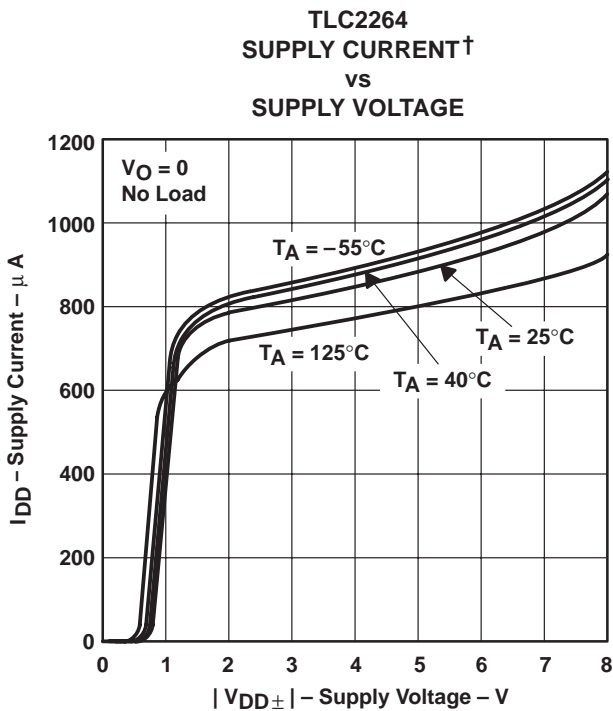

Figure 38

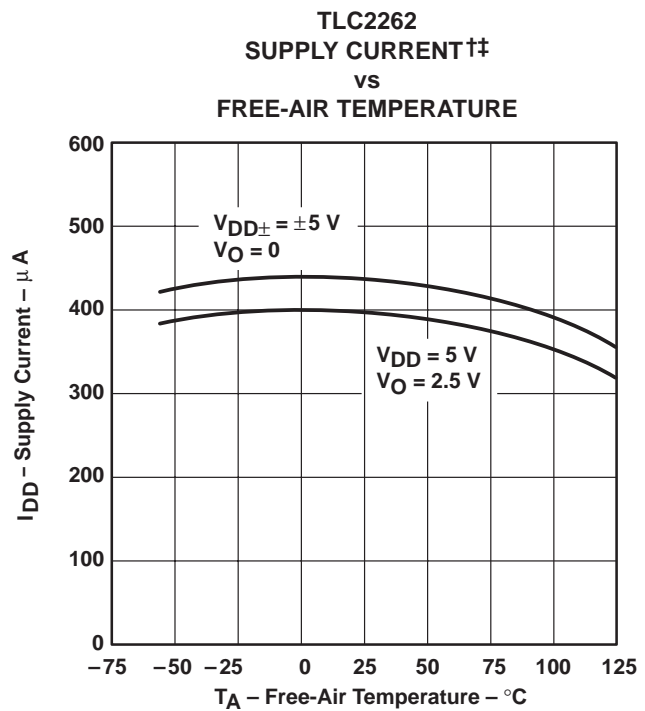
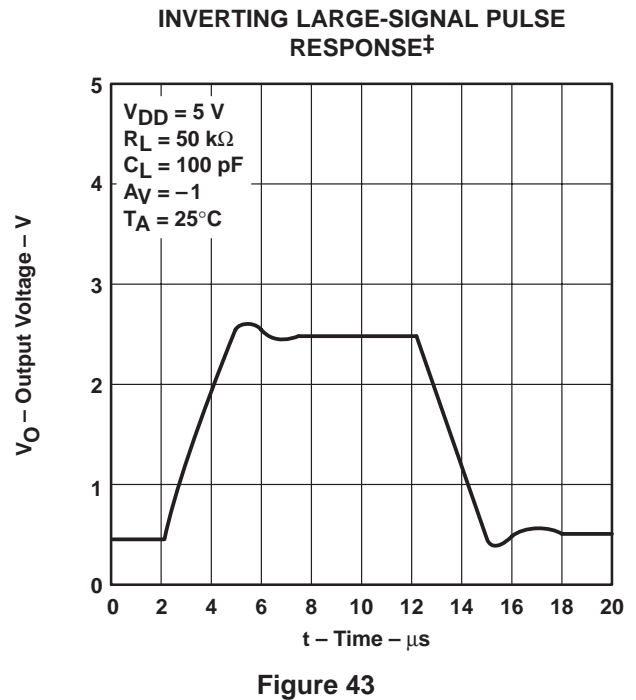
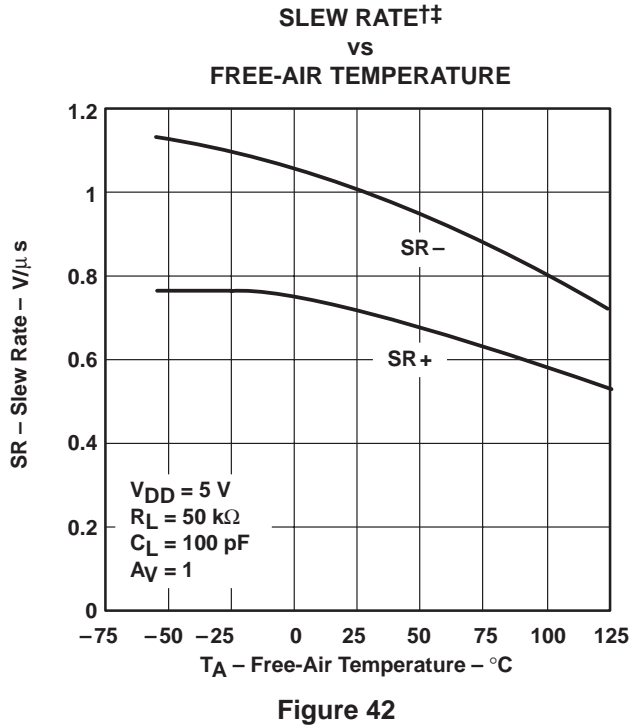
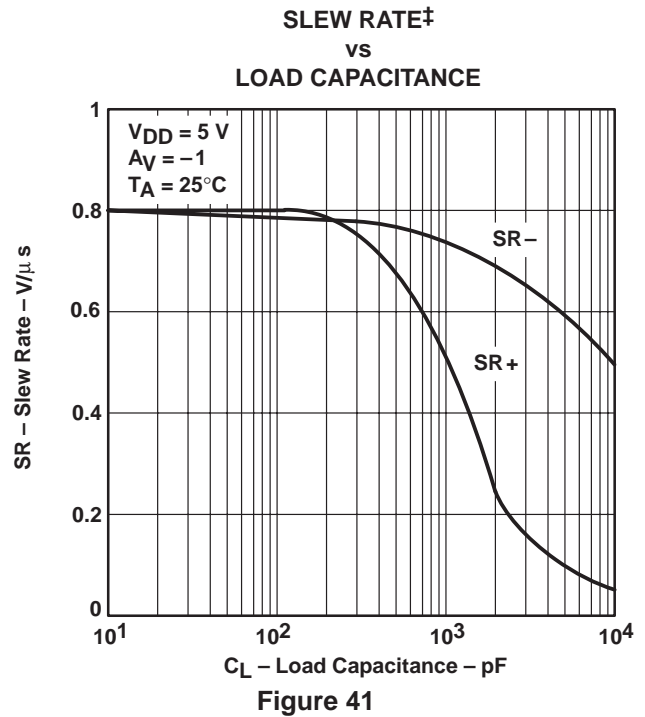
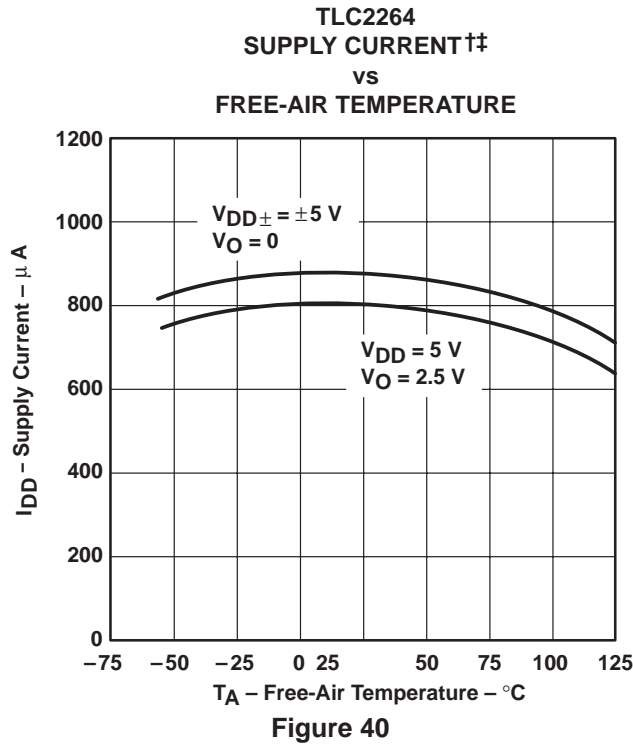

Figure 39

† Data at high and low temperatures are applicable only within the rated operating free-air temperature ranges of the various devices.

†† For curves where $V_{DD} = 5 \text{ V}$, all loads are referenced to 2.5 V.

TYPICAL CHARACTERISTICS



† Data at high and low temperatures are applicable only within the rated operating free-air temperature ranges of the various devices.

‡ For curves where $V_{DD} = 5\text{ V}$, all loads are referenced to 2.5 V.

TYPICAL CHARACTERISTICS

INVERTING LARGE-SIGNAL PULSE RESPONSE

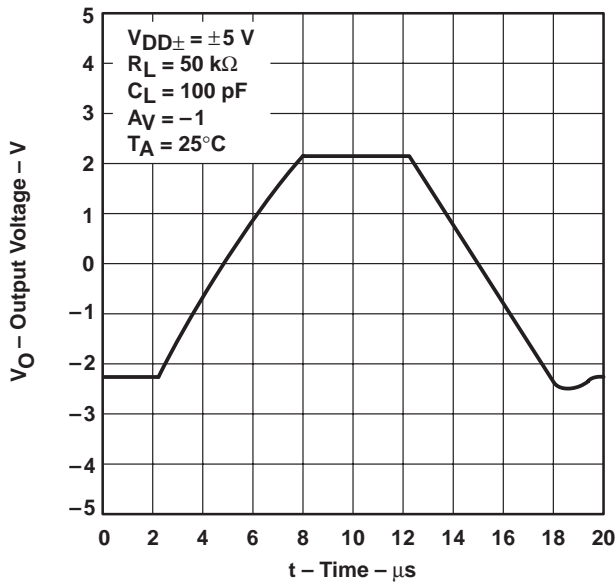

Figure 44

VOLTAGE-FOLLOWER LARGE-SIGNAL PULSE RESPONSE†

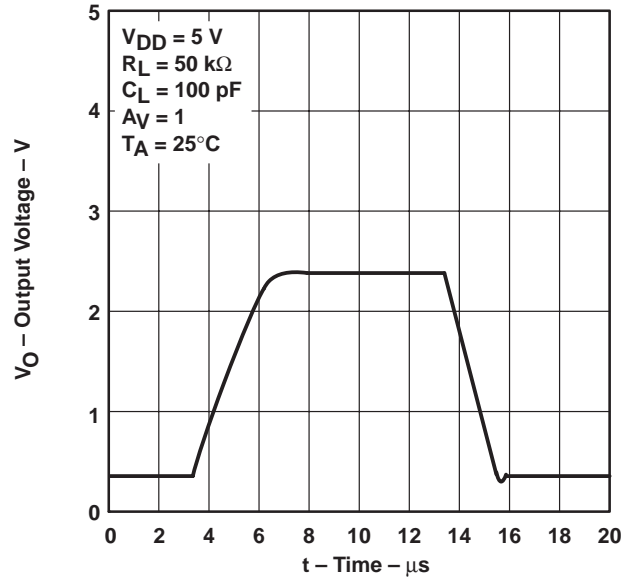

Figure 45

VOLTAGE-FOLLOWER LARGE-SIGNAL PULSE RESPONSE

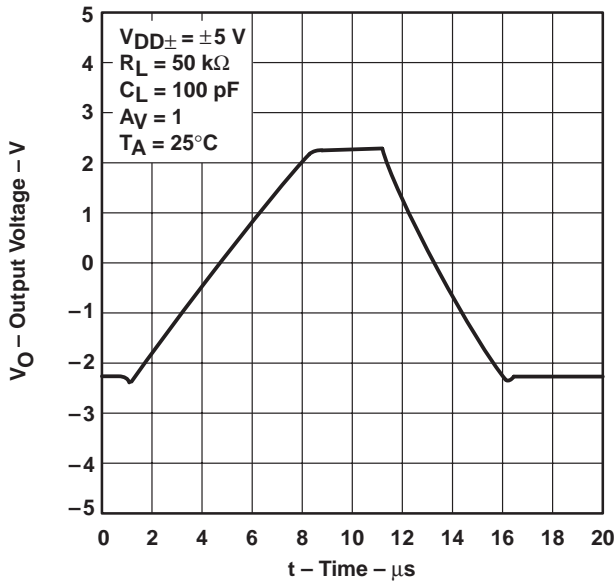

Figure 46

INVERTING SMALL-SIGNAL PULSE RESPONSE†

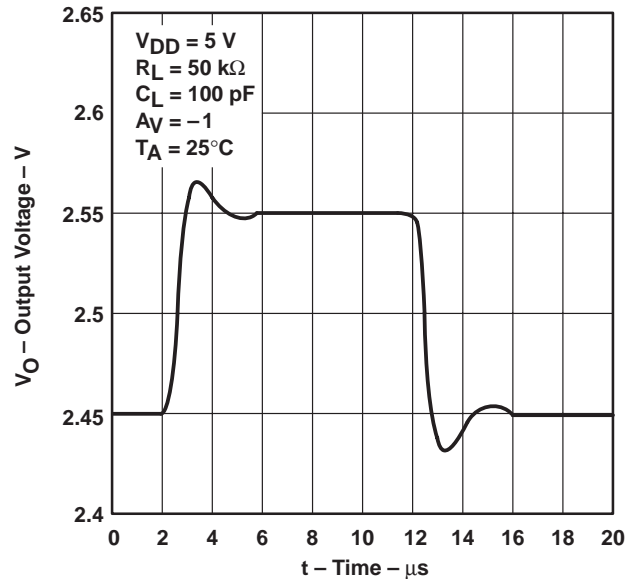

Figure 47

† For curves where $V_{DD} = 5$ V, all loads are referenced to 2.5 V.

TYPICAL CHARACTERISTICS

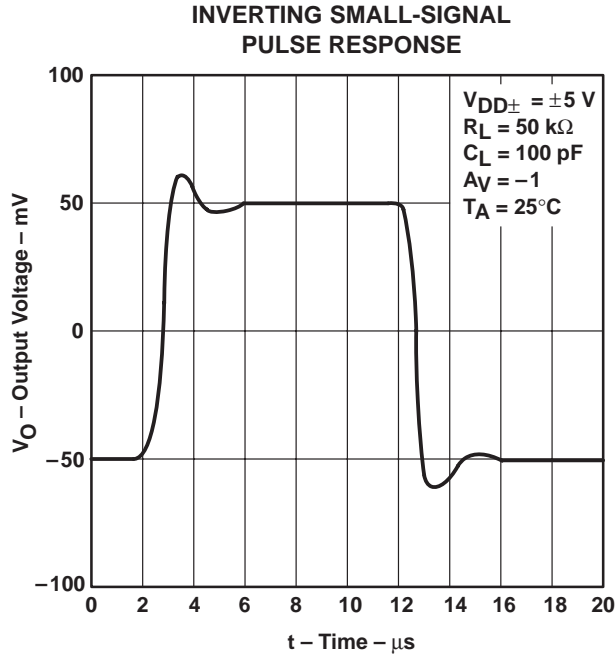

Figure 48

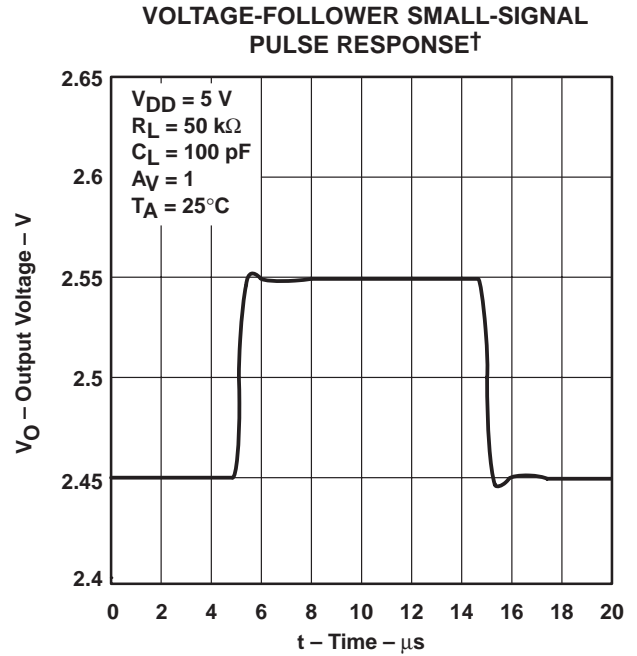

Figure 49

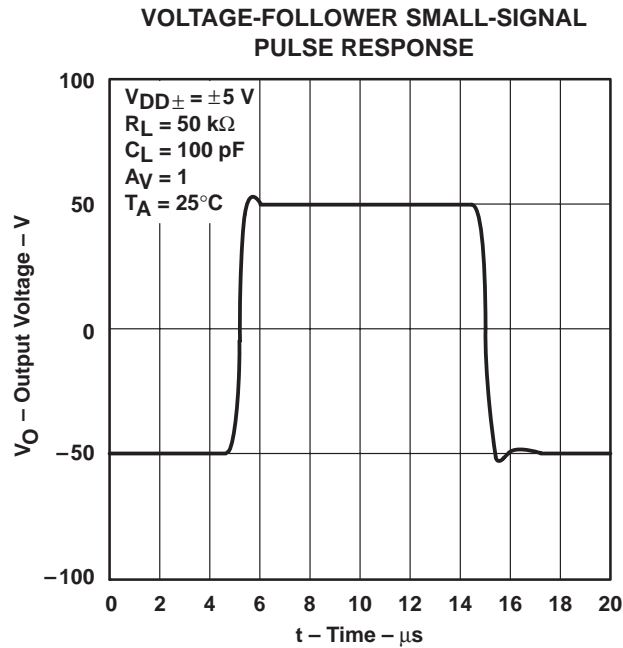

Figure 50

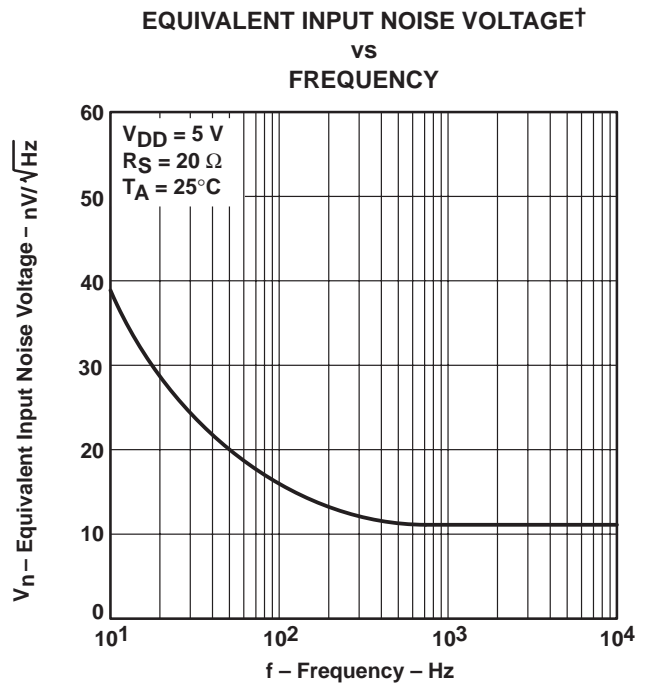

Figure 51

† For curves where $V_{DD} = 5\text{ V}$, all loads are referenced to 2.5 V.

TYPICAL CHARACTERISTICS

EQUIVALENT INPUT NOISE VOLTAGE
 VS
 FREQUENCY

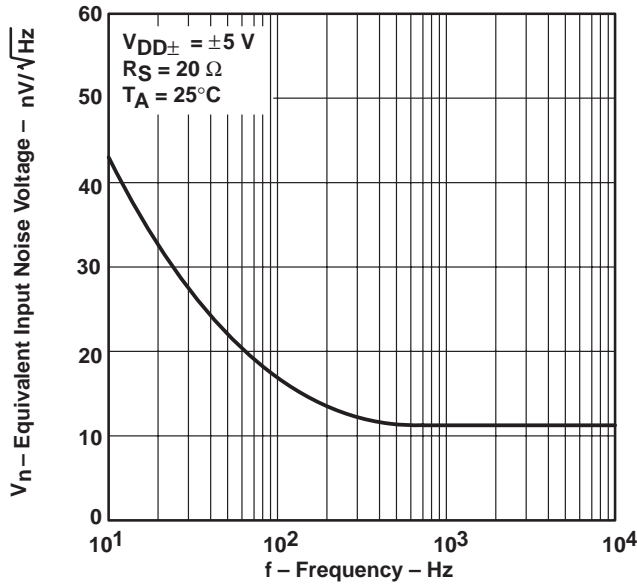

Figure 52

EQUIVALENT INPUT NOISE VOLTAGE OVER
 A 10-SECOND PERIOD†

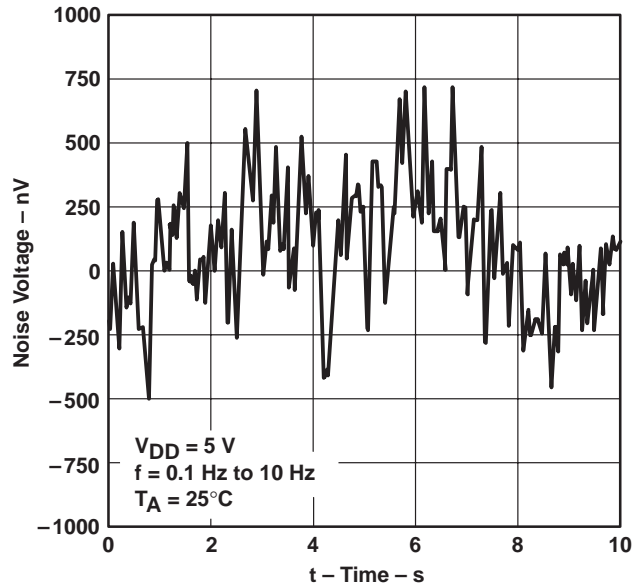

Figure 53

INTEGRATED NOISE VOLTAGE
 VS
 FREQUENCY

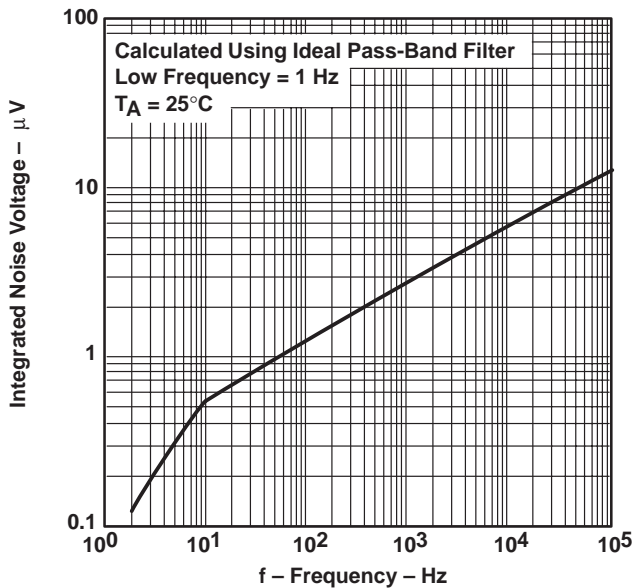

Figure 54

TOTAL HARMONIC DISTORTION PLUS NOISE†
 VS
 FREQUENCY

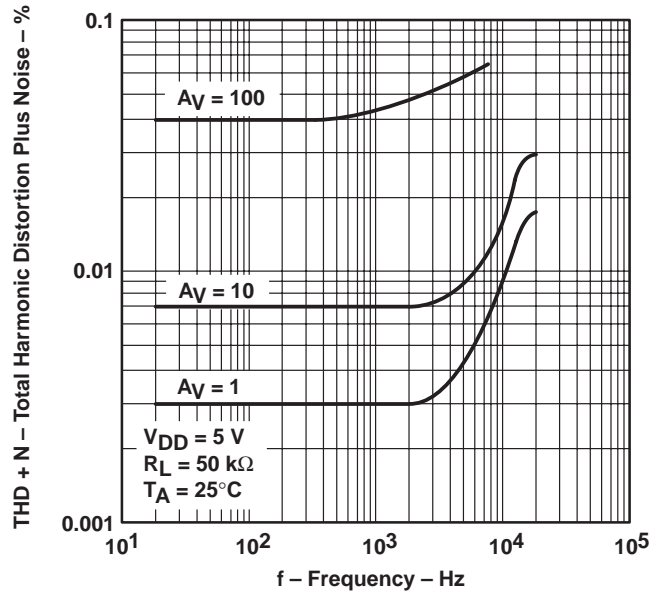

Figure 55

† For curves where $V_{DD} = 5\text{ V}$, all loads are referenced to 2.5 V.

TYPICAL CHARACTERISTICS

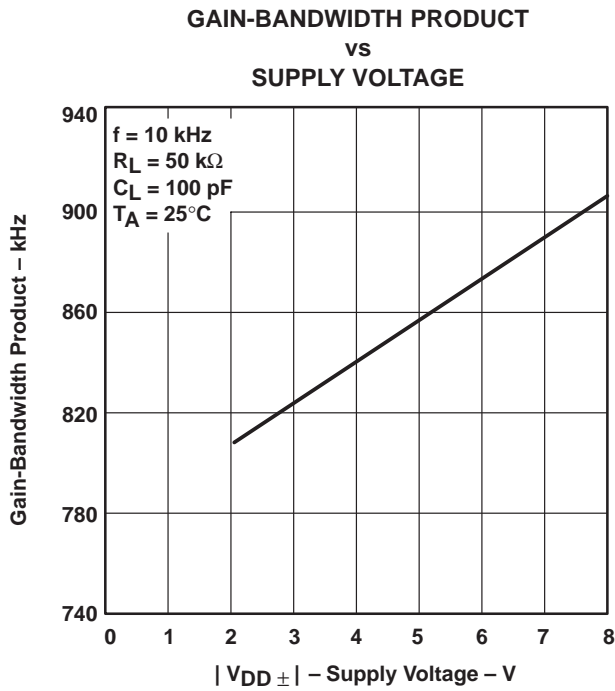

Figure 56

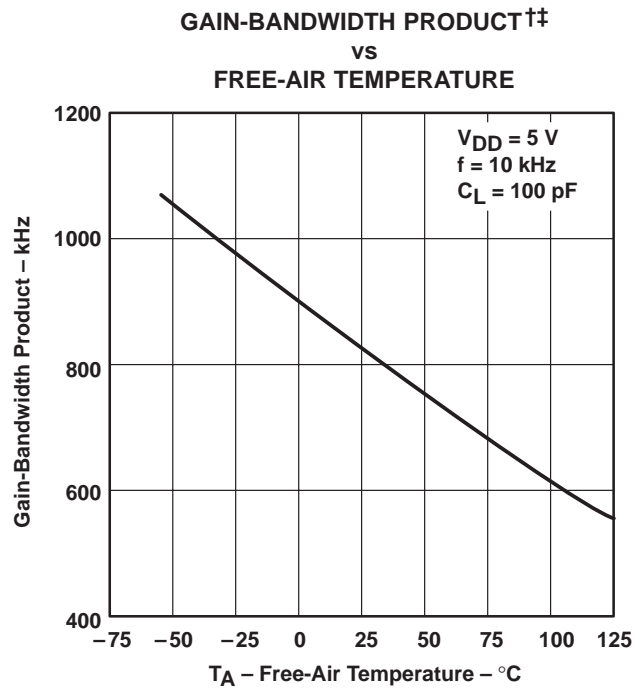

Figure 57

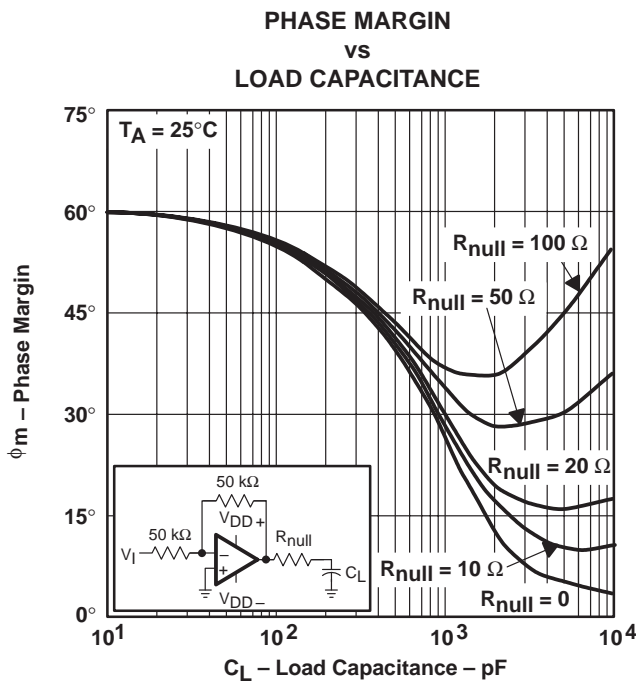

Figure 58

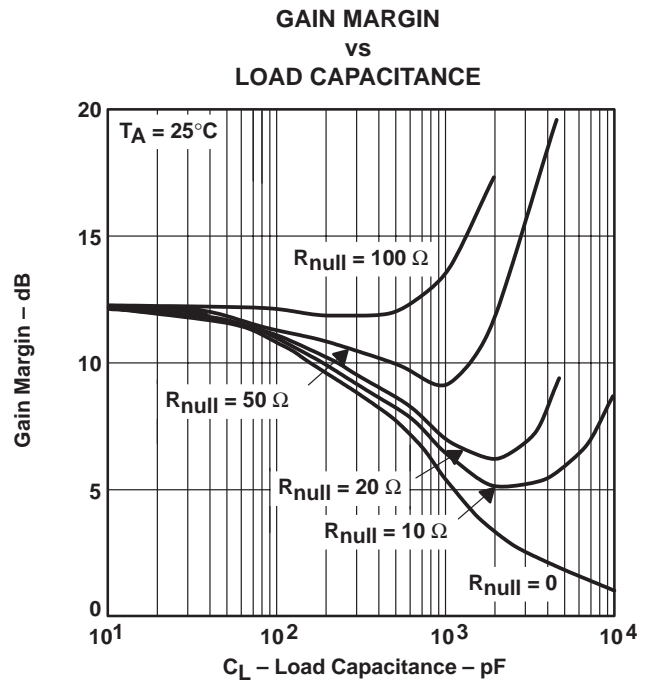

Figure 59

† Data at high and low temperatures are applicable only within the rated operating free-air temperature ranges of the various devices.
 ‡ For curves where $V_{DD} = 5 \text{ V}$, all loads are referenced to 2.5 V.

TYPICAL CHARACTERISTICS

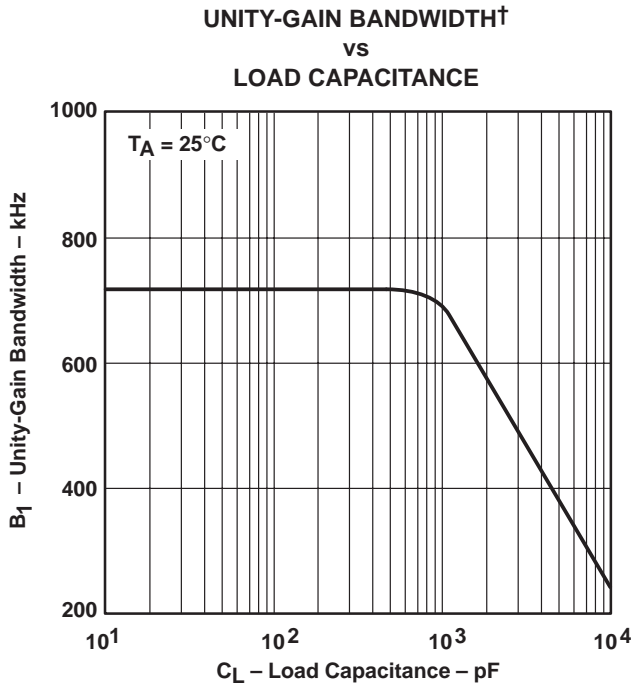

Figure 60

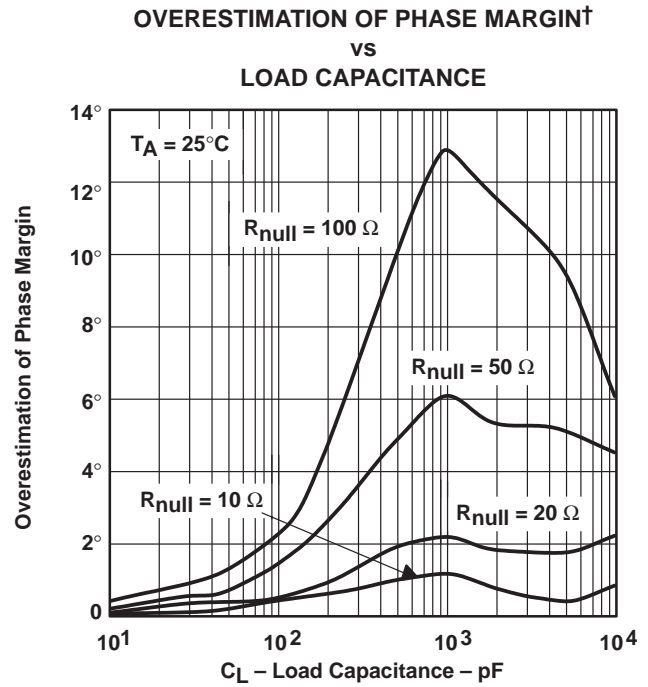

Figure 61

† See application information

APPLICATION INFORMATION

driving large capacitive loads

The TLC226x is designed to drive larger capacitive loads than most CMOS operational amplifiers. Figure 58 and Figure 59 illustrate its ability to drive loads greater than 400 pF while maintaining good gain and phase margins ($R_{null} = 0$).

A smaller series resistor (R_{null}) at the output of the device (see Figure 62) improves the gain and phase margins when driving large capacitive loads. Figure 58 and Figure 59 show the effects of adding series resistances of 10 Ω , 20 Ω , 50 Ω , and 100 Ω . The addition of this series resistor has two effects: the first is that it adds a zero to the transfer function and the second is that it reduces the frequency of the pole associated with the output load in the transfer function.

The zero introduced to the transfer function is equal to the series resistance times the load capacitance. To calculate the improvement in phase margin, equation 1 can be used.

$$\Delta\theta_{m1} = \tan^{-1} \left(2 \times \pi \times \text{UGBW} \times R_{null} \times C_L \right) \quad (1)$$

where :

- $\Delta\theta_{m1}$ = improvement in phase margin
- UGBW = unity-gain bandwidth frequency
- R_{null} = output series resistance
- C_L = load capacitance

The unity-gain bandwidth (UGBW) frequency decreases as the capacitive load increases (see Figure 60). To use equation 1, UGBW must be approximated from Figure 60.

Using equation 1 alone overestimates the improvement in phase margin, as illustrated in Figure 61. The overestimation is caused by the decrease in the frequency of the pole associated with the load, thus providing additional phase shift and reducing the overall improvement in phase margin. The pole associated with the load is reduced by the factor calculated in equation 2.

$$F = \frac{1}{1 + g_m \times R_{null}} \quad (2)$$

Where :

- F = factor reducing frequency of pole
- g_m = small-signal output transconductance (typically 4.83×10^{-3} mhos)
- R_{null} = output series resistance

For the TLC226x, the pole associated with the load is typically 7 MHz with 100-pF load capacitance. This value varies inversely with C_L : at $C_L = 10$ pF, use 70 MHz, at $C_L = 1000$ pF, use 700 kHz, and so on.

Reducing the pole associated with the load introduces phase shift, thereby reducing phase margin. This results in an error in the increase in phase margin expected by considering the zero alone (equation 1). Equation 3 approximates the reduction in phase margin due to the movement of the pole associated with the load. The result of this equation can be subtracted from the result of the equation in equation 1 to better approximate the improvement in phase margin.

APPLICATION INFORMATION

driving large capacitive loads (continued)

$$\Delta\theta_{m2} = \tan^{-1} \left[\frac{UGBW}{(F \times P_2)} \right] - \tan^{-1} \left(\frac{UGBW}{P_2} \right) \tag{3}$$

Where :

$\Delta\theta_{m2}$ = reduction in phase margin

UGBW = unity-gain bandwidth frequency

F = factor from equation 2

P_2 = unadjusted pole (70 MHz @10 pF, 7 MHz @100 pF, etc.)

Using these equations with Figure 60 and Figure 61 enables the designer to choose the appropriate output series resistance to optimize the design of circuits driving large capacitive loads.

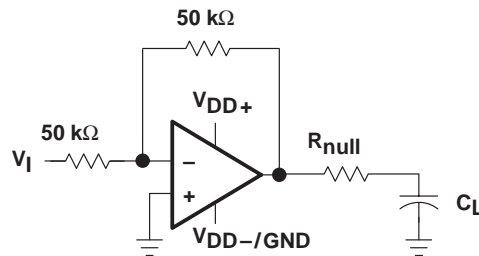

Figure 62. Series-Resistance Circuit

APPLICATION INFORMATION

macromodel information

Macromodel information provided was derived using Microsim *Parts*™, the model generation software used with Microsim *PSpice*™. The Boyle macromodel (see Note 5) and subcircuit in Figure 63 are generated using the TLC226x typical electrical and operating characteristics at $T_A = 25^\circ\text{C}$. Using this information, output simulations of the following key parameters can be generated to a tolerance of 20% (in most cases):

- Maximum positive output voltage swing
- Maximum negative output voltage swing
- Slew rate
- Quiescent power dissipation
- Input bias current
- Open-loop voltage amplification
- Unity-gain frequency
- Common-mode rejection ratio
- Phase margin
- DC output resistance
- AC output resistance
- Short-circuit output current limit

NOTE 5: G. R. Boyle, B. M. Cohn, D. O. Pederson, and J. E. Solomon, "Macromodeling of Intergrated Circuit Operational Amplifiers," *IEEE Journal of Solid-State Circuits*, SC-9, 353 (1974).

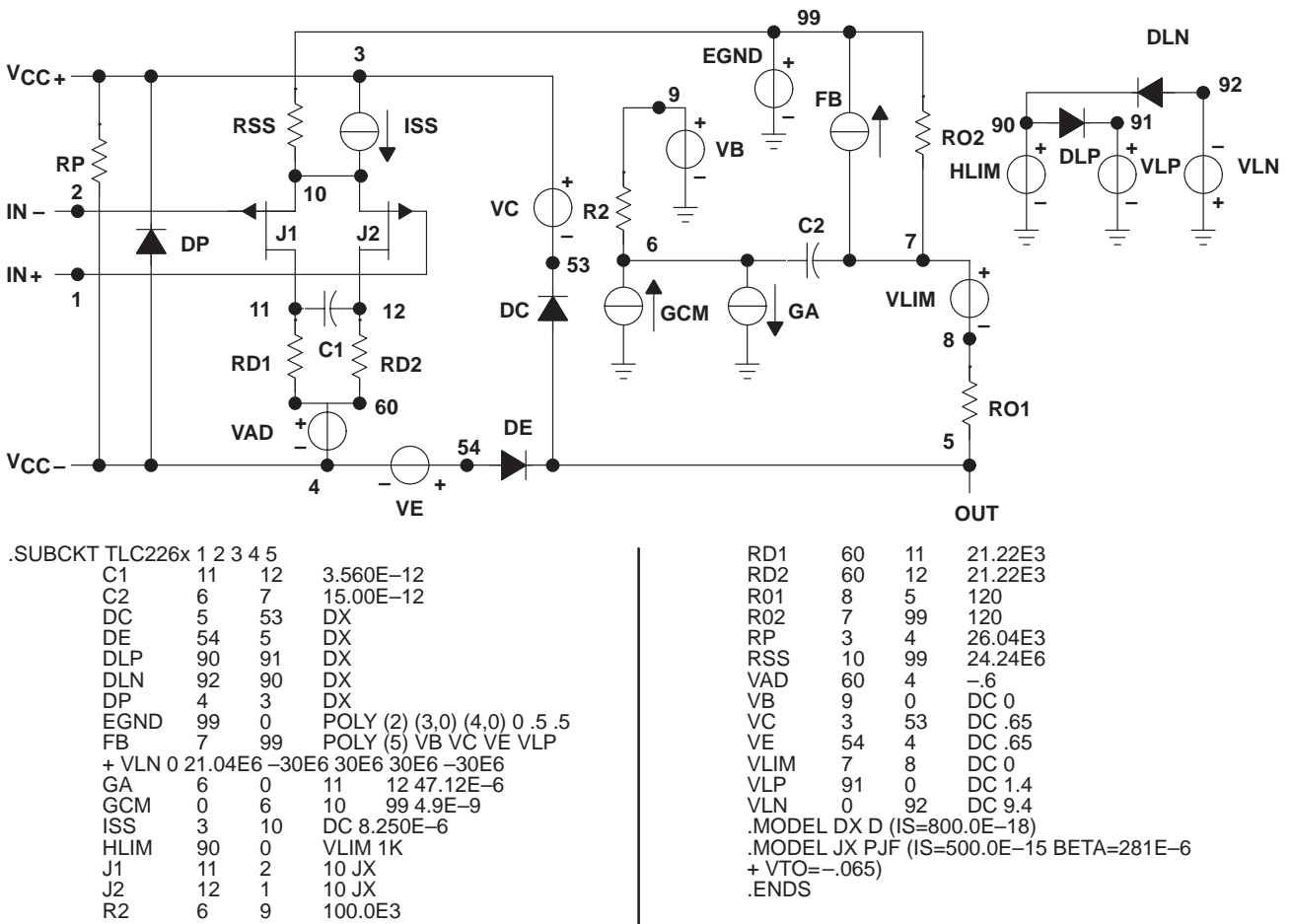

Figure 63. Boyle Macromodel and Subcircuit

PSpice and *Parts* are trademarks of MicroSim Corporation.

TLC226x, TLC226xA
Advanced LinCMOS™ RAIL-TO-RAIL
OPERATIONAL AMPLIFIERS

SLOS177A – FEBRUARY 1997 – REVISED JULY 1999

MECHANICAL INFORMATION

D (R-PDSO-G)**

PLASTIC SMALL-OUTLINE PACKAGE

14 PIN SHOWN

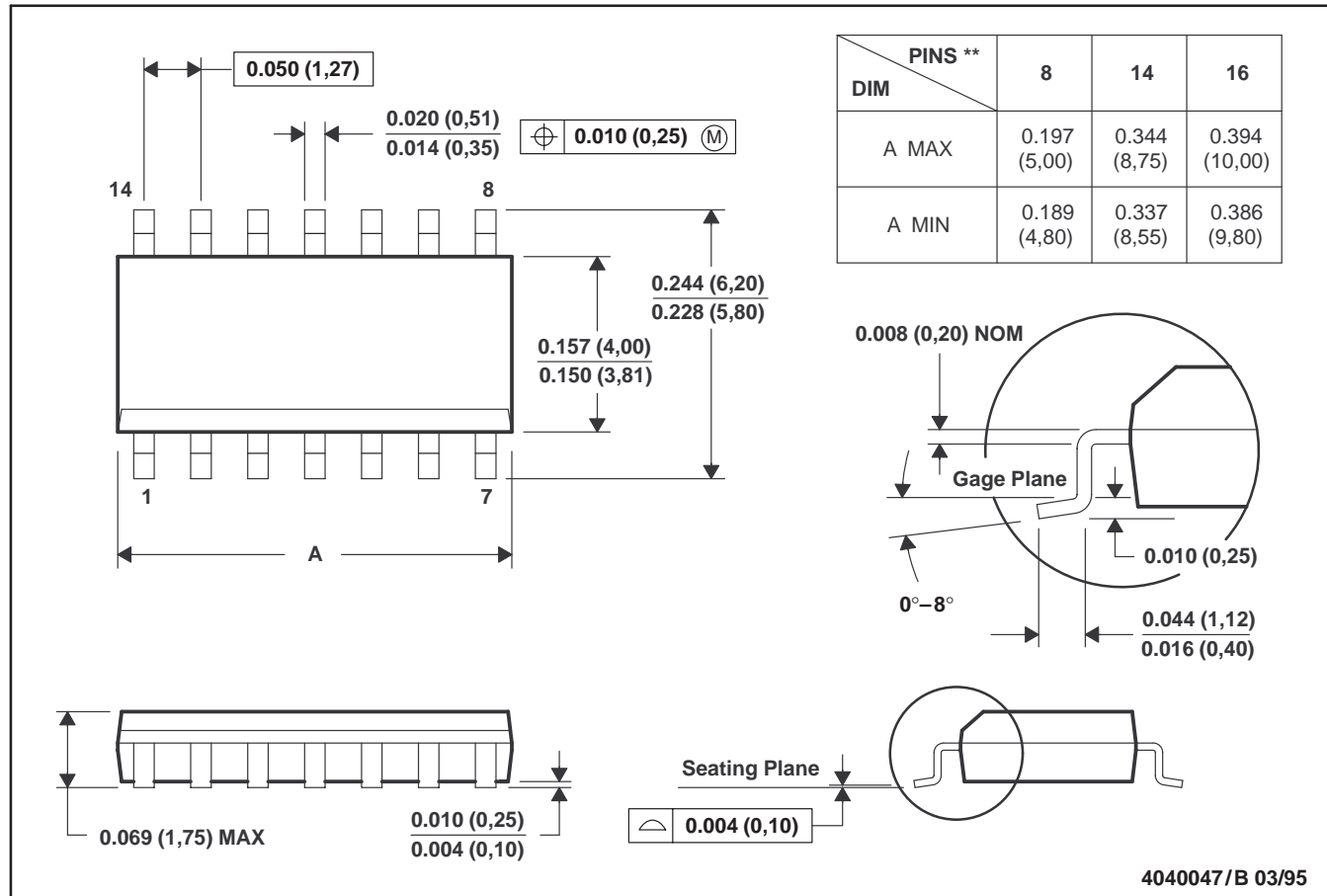

- NOTES: A. All linear dimensions are in inches (millimeters).
 B. This drawing is subject to change without notice.
 C. Body dimensions do not include mold flash or protrusion, not to exceed 0.006 (0,15).
 D. Four center pins are connected to die mount pad.
 E. Falls within JEDEC MS-012

MECHANICAL INFORMATION

FK (S-CQCC-N**)

LEADLESS CERAMIC CHIP CARRIER

28 TERMINAL SHOWN

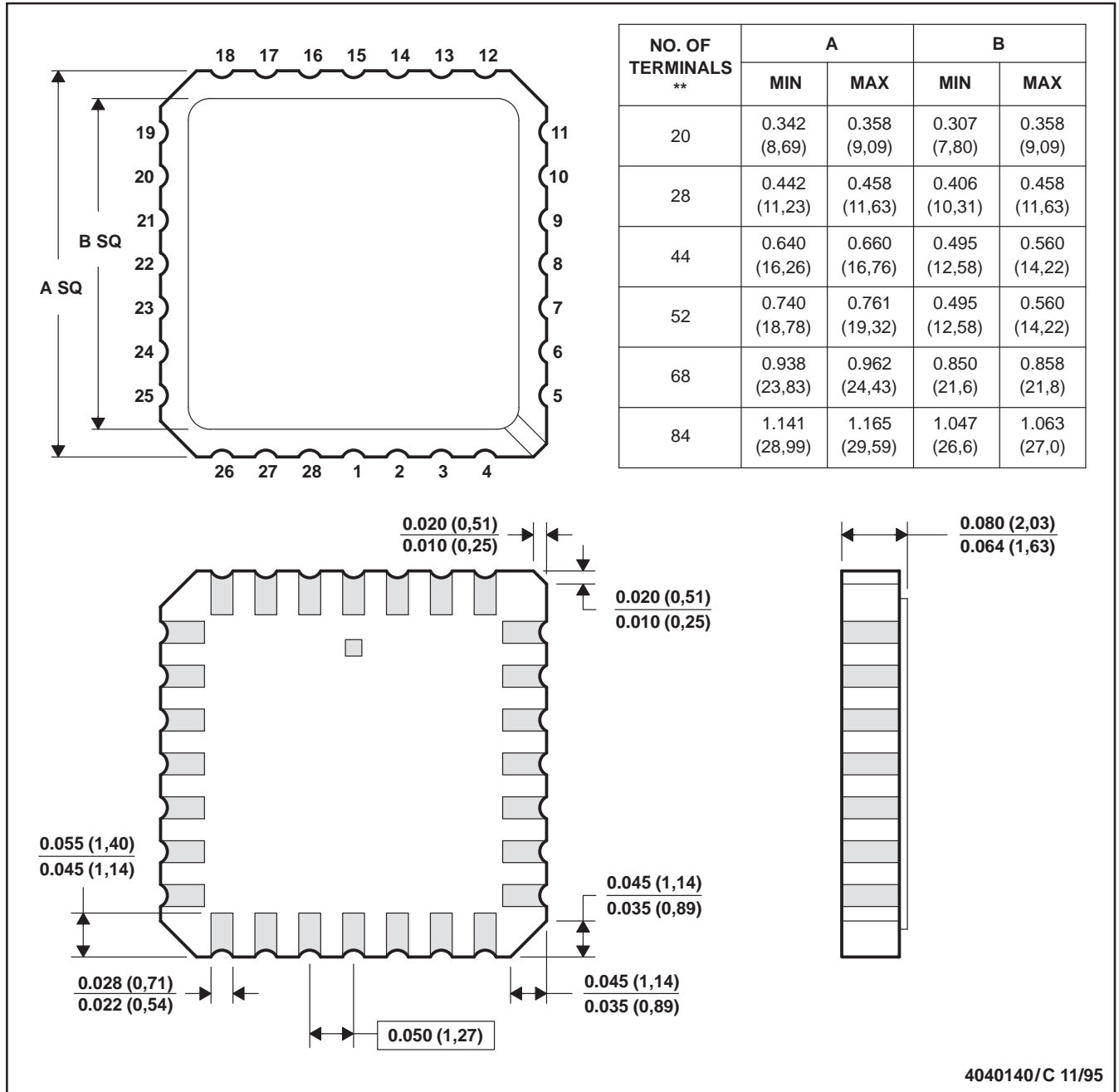

- NOTES: A. All linear dimensions are in inches (millimeters).
 B. This drawing is subject to change without notice.
 C. This package can be hermetically sealed with a metal lid.
 D. The terminals are gold plated.
 E. Falls within JEDEC MS-004

TLC226x, TLC226xA
Advanced LinCMOS™ RAIL-TO-RAIL
OPERATIONAL AMPLIFIERS

SLOS177A – FEBRUARY 1997 – REVISED JULY 1999

MECHANICAL INFORMATION

J (R-GDIP-T)**

CERAMIC DUAL-IN-LINE PACKAGE

14 PIN SHOWN

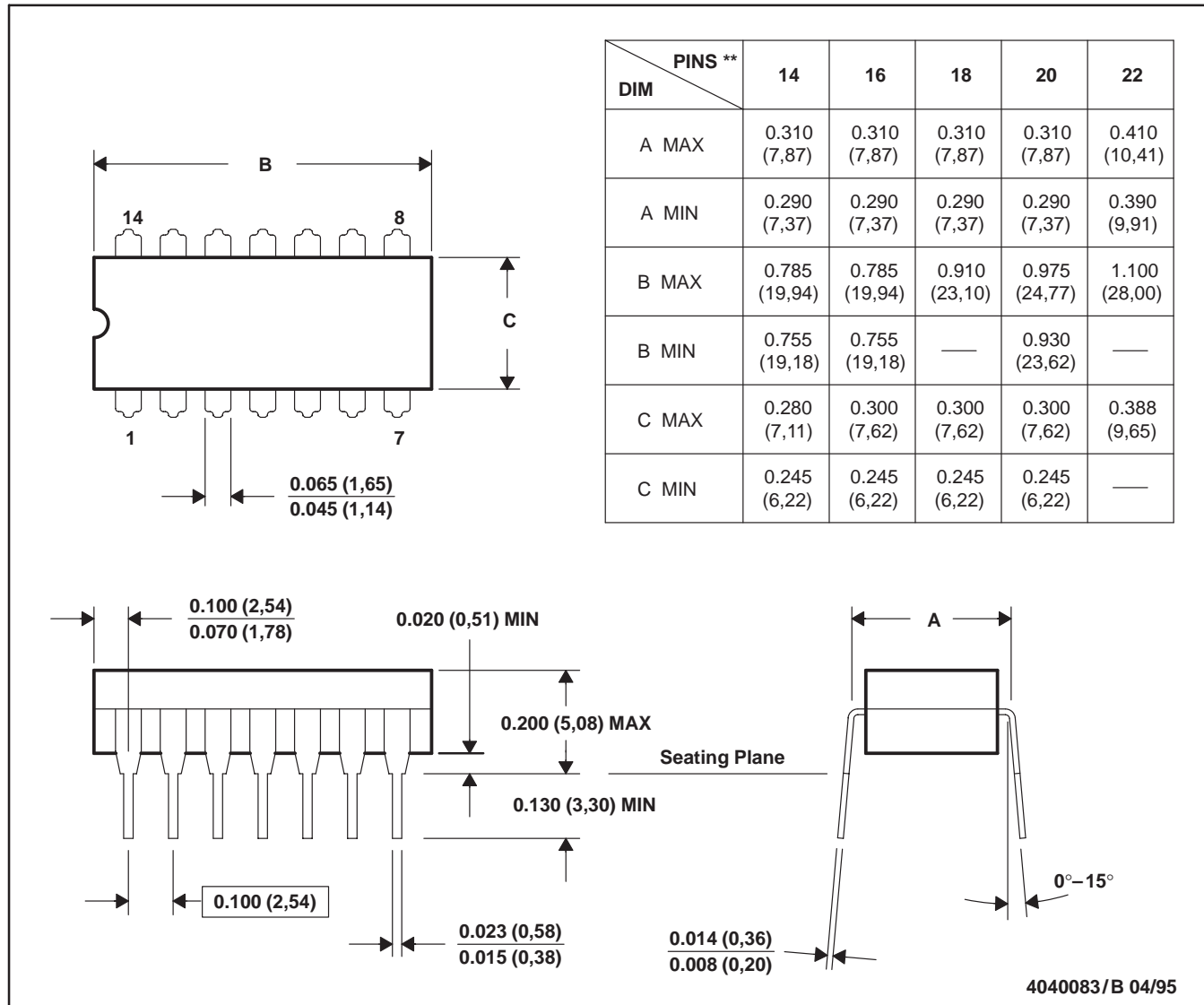

4040083/B 04/95

- NOTES:
- A. All linear dimensions are in inches (millimeters).
 - B. This drawing is subject to change without notice.
 - C. This package can be hermetically sealed with a ceramic lid using glass frit.
 - D. Index point is provided on cap for terminal identification only on press ceramic glass frit seal only.
 - E. Falls within MIL-STD-1835 GDIP1-T14, GDIP1-T16, GDIP1-T18, GDIP1-T20, and GDIP1-T22



POST OFFICE BOX 655303 • DALLAS, TEXAS 75265

MECHANICAL INFORMATION

JG (R-GDIP-T8)

CERAMIC DUAL-IN-LINE PACKAGE

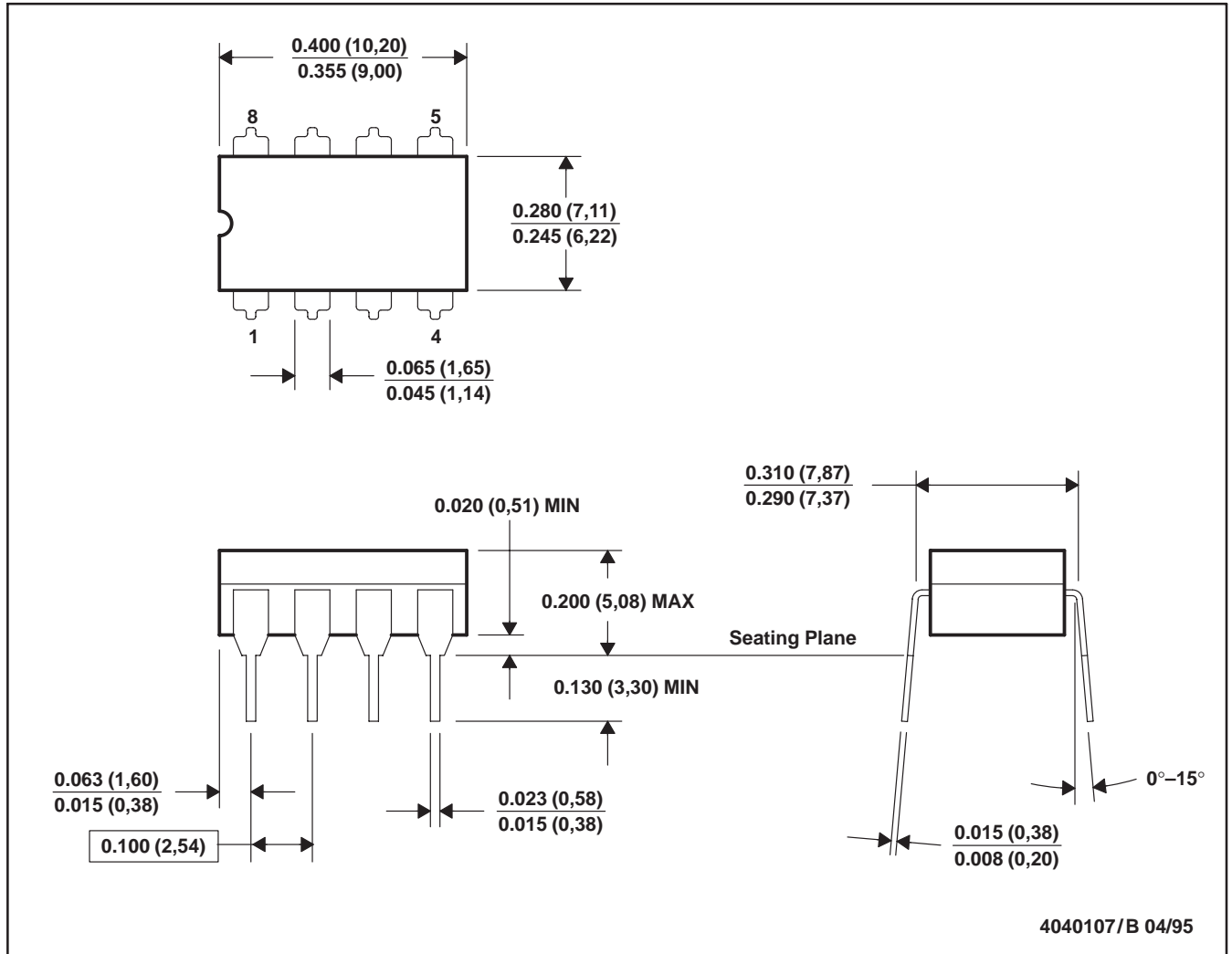

- NOTES: A. All linear dimensions are in inches (millimeters).
 B. This drawing is subject to change without notice.
 C. This package can be hermetically sealed with a ceramic lid using glass frit.
 D. Index point is provided on cap for terminal identification only on press ceramic glass frit seal only
 E. Falls within MIL-STD-1835 GDIP1-T8

TLC226x, TLC226xA
Advanced LinCMOS™ RAIL-TO-RAIL
OPERATIONAL AMPLIFIERS

SLOS177A – FEBRUARY 1997 – REVISED JULY 1999

MECHANICAL INFORMATION

N (R-PDIP-T)**

PLASTIC DUAL-IN-LINE PACKAGE

16 PIN SHOWN

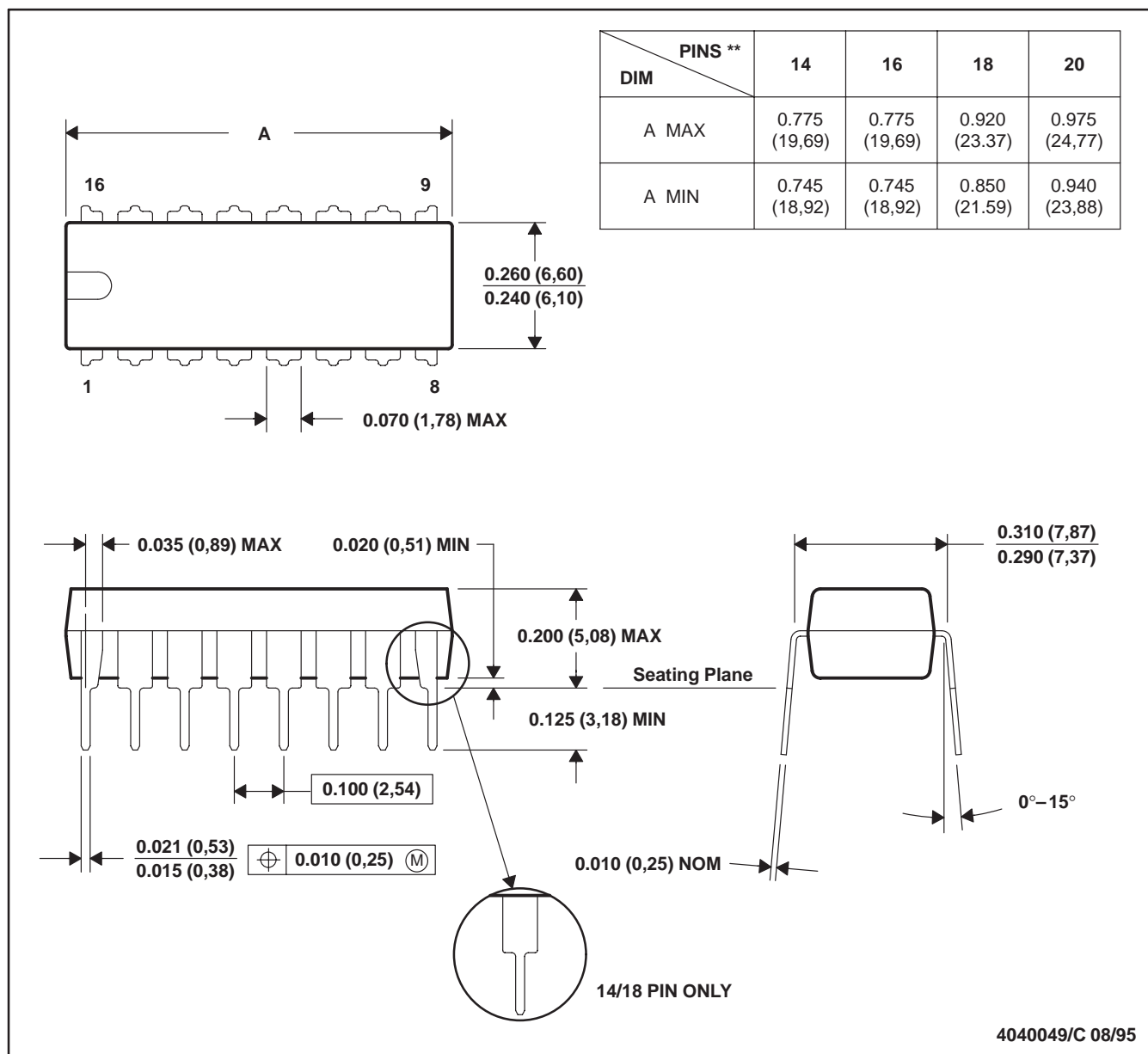

4040049/C 08/95

- NOTES: A. All linear dimensions are in inches (millimeters).
 B. This drawing is subject to change without notice.
 C. Falls within JEDEC MS-001 (20 pin package is shorter than MS-001.)



POST OFFICE BOX 655303 • DALLAS, TEXAS 75265

MECHANICAL INFORMATION

P (R-PDIP-T8)

PLASTIC DUAL-IN-LINE PACKAGE

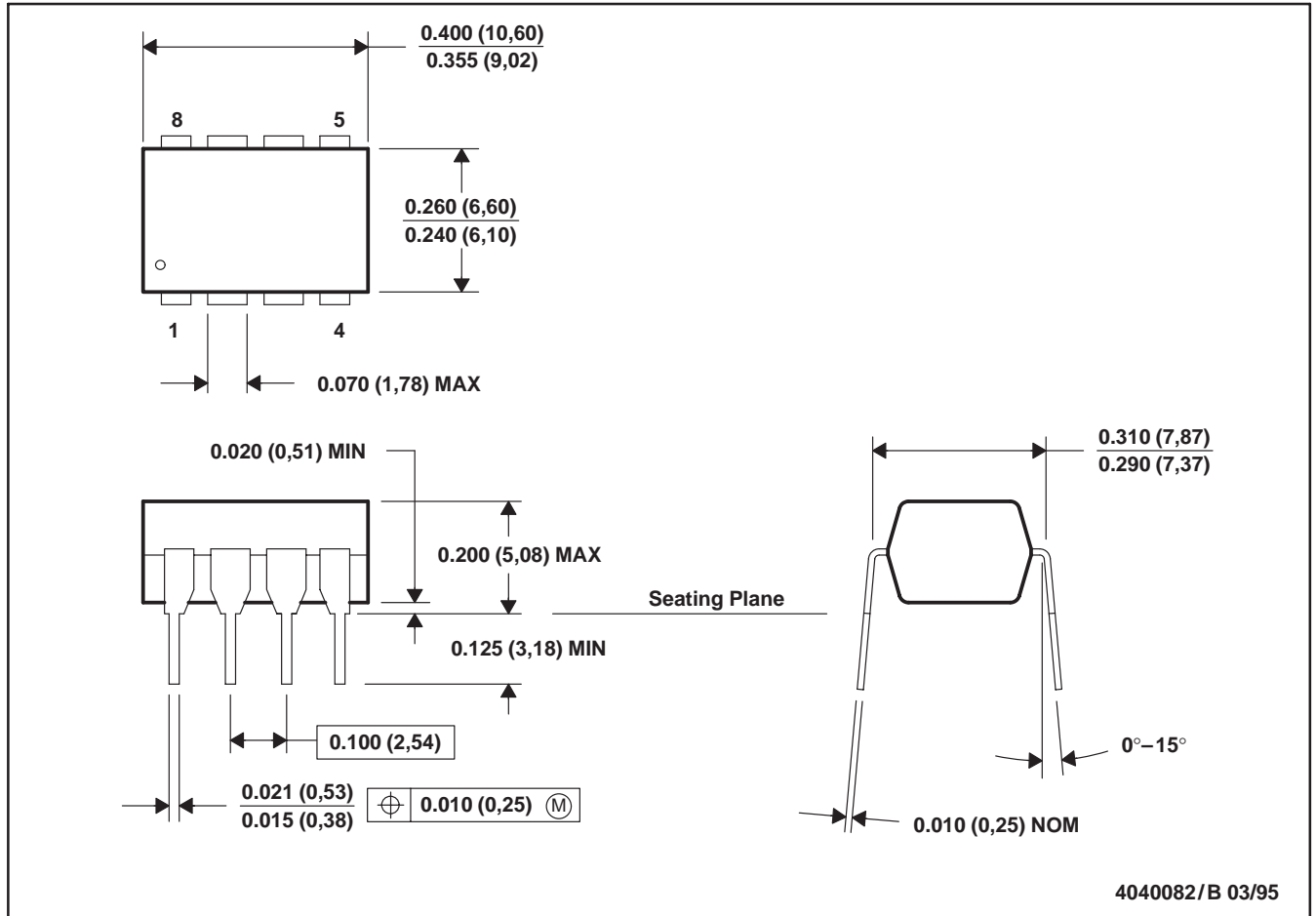

- NOTES: A. All linear dimensions are in inches (millimeters).
 B. This drawing is subject to change without notice.
 C. Falls within JEDEC MS-001

TLC226x, TLC226xA
Advanced LinCMOS™ RAIL-TO-RAIL
OPERATIONAL AMPLIFIERS

SLOS177A – FEBRUARY 1997 – REVISED JULY 1999

MECHANICAL INFORMATION

PW (R-PDSO-G)**

PLASTIC SMALL-OUTLINE PACKAGE

14 PIN SHOWN

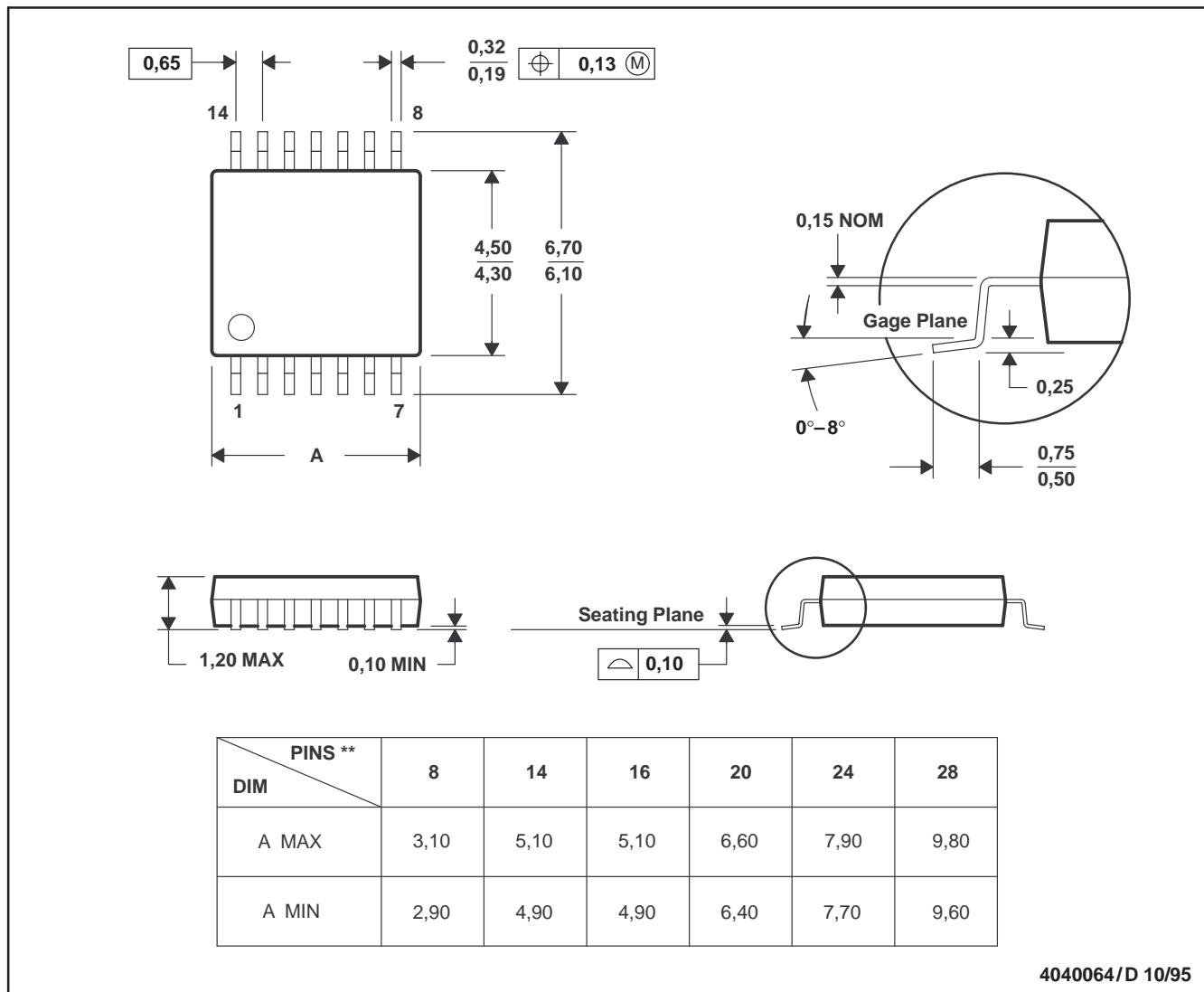

4040064/D 10/95

- NOTES: A. All linear dimensions are in millimeters.
 B. This drawing is subject to change without notice.
 C. Body dimensions do not include mold flash or protrusion not to exceed 0,15.
 D. Falls within JEDEC MO-153

MECHANICAL INFORMATION

U (S-GDFP-F10)

CERAMIC DUAL FLATPACK

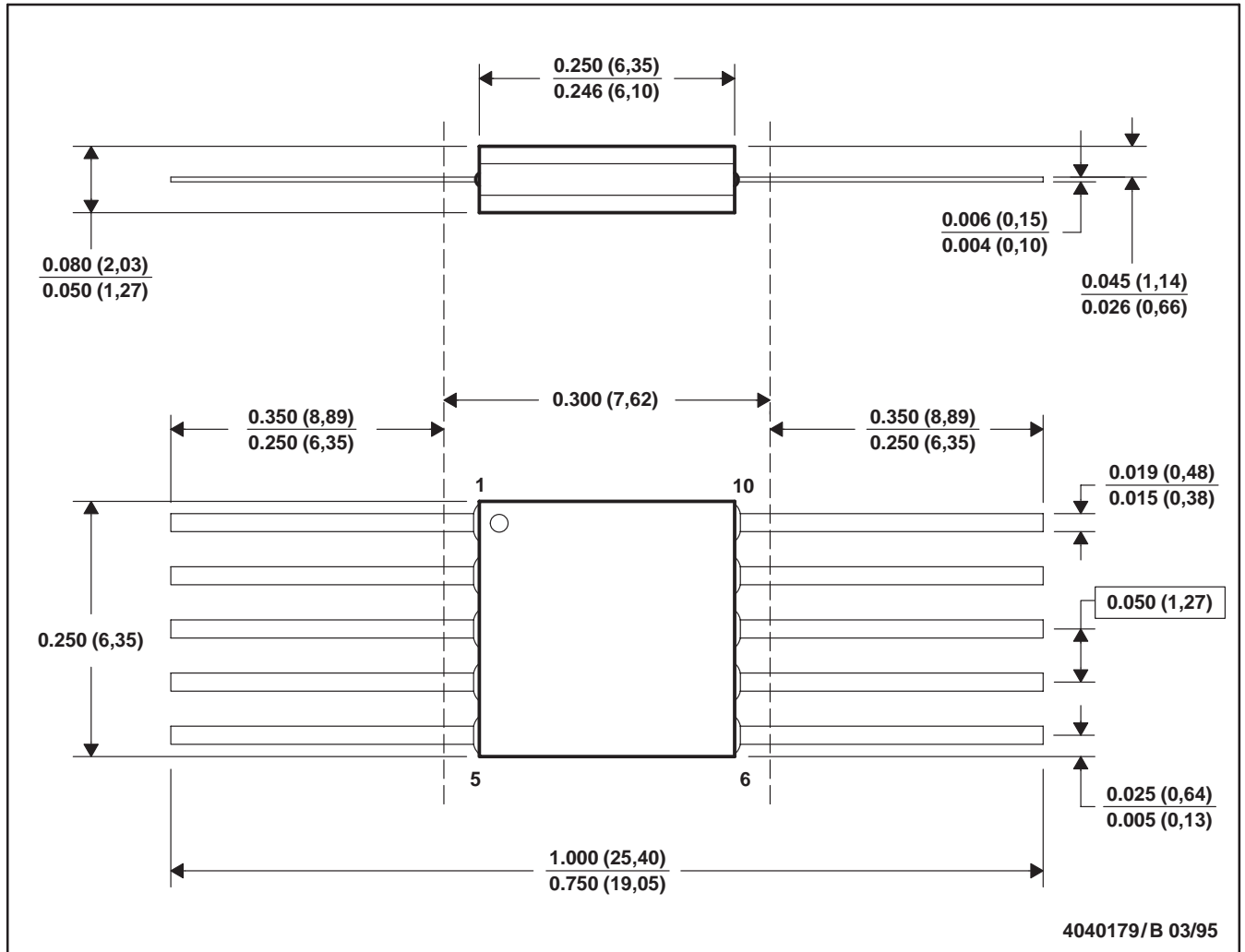

- NOTES: A. All linear dimensions are in inches (millimeters).
 B. This drawing is subject to change without notice.
 C. This package can be hermetically sealed with a ceramic lid using glass frit.
 D. Index point is provided on cap for terminal identification only.
 E. Falls within MIL STD 1835 GDFP1-F10 and JEDEC MO-092AA

TLC226x, TLC226xA
Advanced LinCMOS™ RAIL-TO-RAIL
OPERATIONAL AMPLIFIERS

SLOS177A – FEBRUARY 1997 – REVISED JULY 1999

MECHANICAL INFORMATION

W (R-GDFP-F16)

CERAMIC DUAL FLATPACK

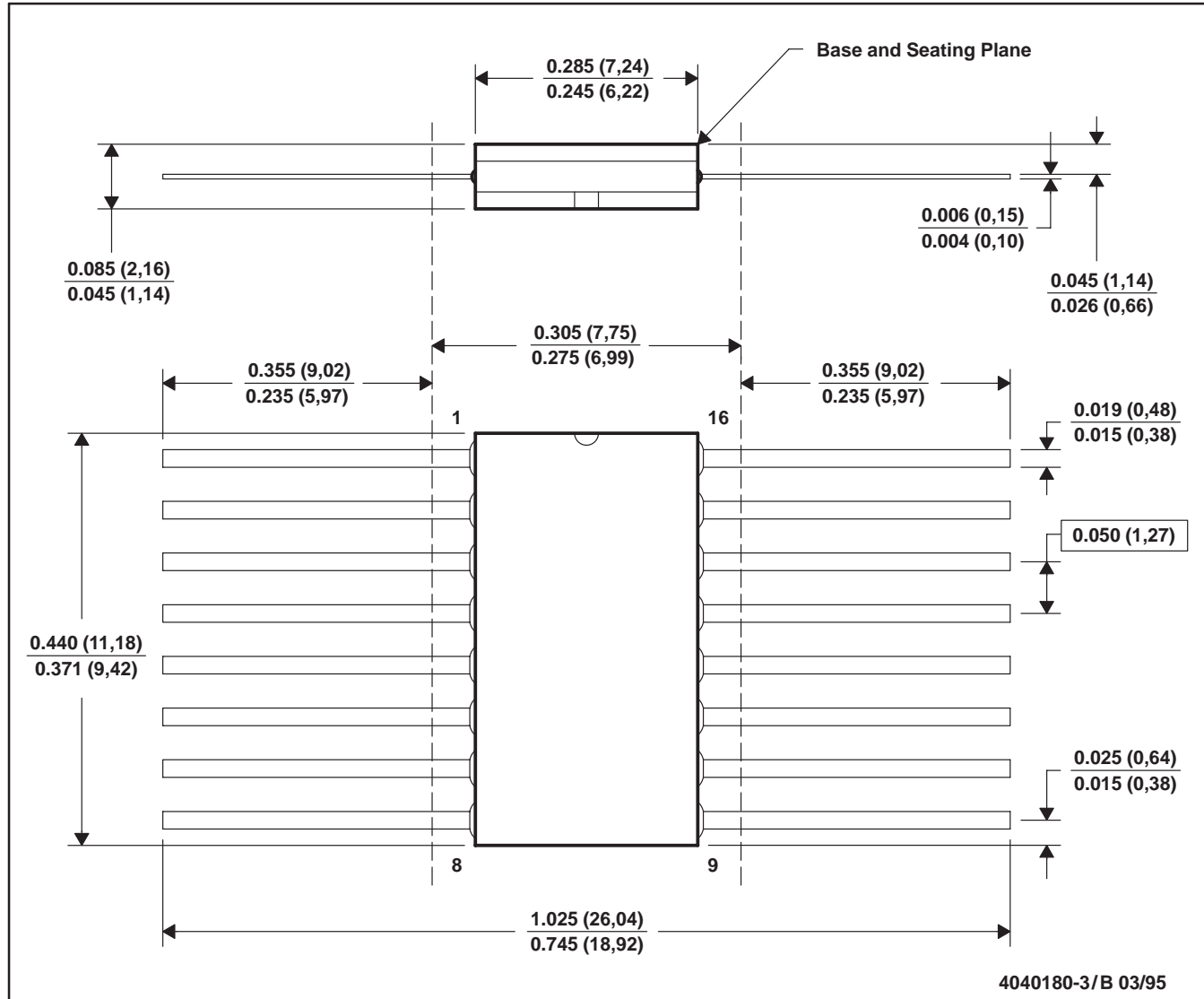

- NOTES:
- A. All linear dimensions are in inches (millimeters).
 - B. This drawing is subject to change without notice.
 - C. This package can be hermetically sealed with a ceramic lid using glass frit.
 - D. Index point is provided on cap for terminal identification only.
 - E. Falls within MIL-STD-1835 GDFP1-F16 and JEDEC MO-092AC

IMPORTANT NOTICE

Texas Instruments and its subsidiaries (TI) reserve the right to make changes to their products or to discontinue any product or service without notice, and advise customers to obtain the latest version of relevant information to verify, before placing orders, that information being relied on is current and complete. All products are sold subject to the terms and conditions of sale supplied at the time of order acknowledgement, including those pertaining to warranty, patent infringement, and limitation of liability.

TI warrants performance of its semiconductor products to the specifications applicable at the time of sale in accordance with TI's standard warranty. Testing and other quality control techniques are utilized to the extent TI deems necessary to support this warranty. Specific testing of all parameters of each device is not necessarily performed, except those mandated by government requirements.

CERTAIN APPLICATIONS USING SEMICONDUCTOR PRODUCTS MAY INVOLVE POTENTIAL RISKS OF DEATH, PERSONAL INJURY, OR SEVERE PROPERTY OR ENVIRONMENTAL DAMAGE ("CRITICAL APPLICATIONS"). TI SEMICONDUCTOR PRODUCTS ARE NOT DESIGNED, AUTHORIZED, OR WARRANTED TO BE SUITABLE FOR USE IN LIFE-SUPPORT DEVICES OR SYSTEMS OR OTHER CRITICAL APPLICATIONS. INCLUSION OF TI PRODUCTS IN SUCH APPLICATIONS IS UNDERSTOOD TO BE FULLY AT THE CUSTOMER'S RISK.

In order to minimize risks associated with the customer's applications, adequate design and operating safeguards must be provided by the customer to minimize inherent or procedural hazards.

TI assumes no liability for applications assistance or customer product design. TI does not warrant or represent that any license, either express or implied, is granted under any patent right, copyright, mask work right, or other intellectual property right of TI covering or relating to any combination, machine, or process in which such semiconductor products or services might be or are used. TI's publication of information regarding any third party's products or services does not constitute TI's approval, warranty or endorsement thereof.