

Features

- Operating voltage: 2.5V~5.5V
- Low power consumption
- Low cost 32768Hz crystal
- CPT Band: 305~640Hz detection
- Good performance:
 - 8 ~ -39 dBm at $V_{DD}=2.5V$
 - 0 ~ -27 dBm at $V_{DD}=5V$
- 8-pin DIP package

General Description

The HT9020B call progress tone detector is a telecom peripheral for Auto-dialing system use.

Switched capacitors technology is implemented into the chip to get good performance characteristics of band pass filter in the range of 305 to 640Hz call progress tone which is dual tone multi-frequency signal.

When it detected CPT signal then it generates relative envelopes for external microcontroller decision to finish different kinds of CPT signal detection such as dial tone, busy tone, ring-back tone and reorder tone.

Block Diagram

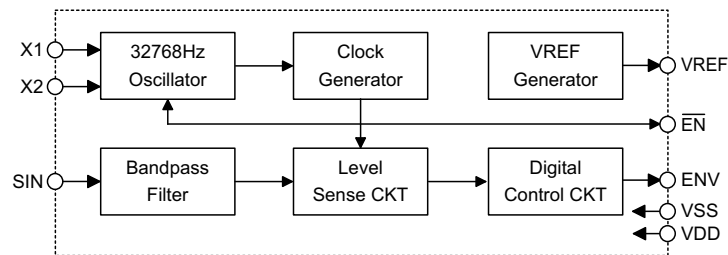

Pin Assignment

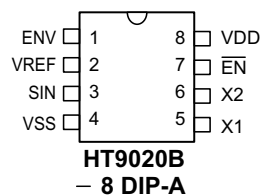

Pin Description

Pin Name	I/O	Internal Connection	Description
ENV	O	CMOS OUT	While an input signal is within specification, this pin will output the envelope relative to the input signal with a typical 40ms timing delay.
VREF	O	CMOS OUT	1/2 V _{DD} reference voltage output pin When EN=V _{DD} , the device will be turned off and VREF disabled.
SIN	I	CMOS IN	AC coupled analog signal input pin
VSS	—	—	Negative power supply, ground
VDD	—	—	Positive power supply
$\overline{\text{EN}}$	I	CMOS IN	$\overline{\text{EN}}=V_{\text{SS}}$; Normal operation mode EN=V _{DD} ; Device disabled.
X1	I	OSCILLATOR	The system oscillator consists of an inverter, a bias resistor and the necessary on-chip load capacitor. Connect a standard 32.768kHz crystal or ceramic resonator.
X2	O	OSCILLATOR	X1 and X2 terminals implement the oscillator function. The oscillator is turned off in the standby mode.

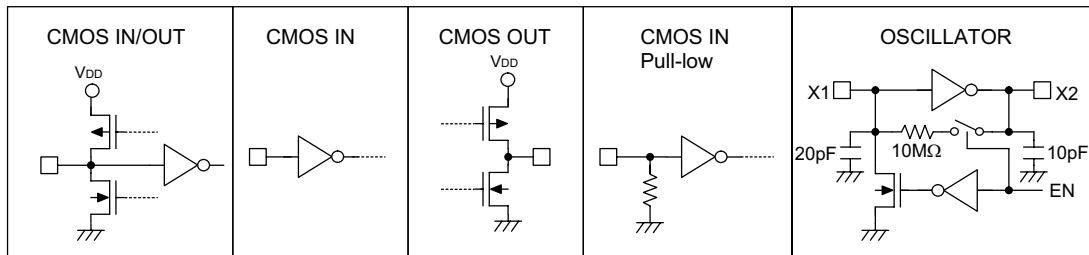
Approximate internal connection circuits

Absolute Maximum Ratings

Supply Voltage.....V _{SS} -0.3V to V _{DD} +6V	Storage Temperature.....-55°C to 150°C
Input Voltage V _{SS} -0.3V to V _{DD} +0.3V	Operating Temperature-20°C to 75°C

Note: These are stress ratings only. Stresses exceeding the range specified under "Absolute Maximum Ratings" may cause substantial damage to the device. Functional operation of this device at other conditions beyond those listed in the specification is not implied and prolonged exposure to extreme conditions may affect device reliability.

Electrical Characteristics

Symbol	Parameter	Test Conditions		Min.	Typ.	Max.	Unit
		V _{DD}	Conditions				
V _{DD}	Operating Voltage	—	—	2.5	—	5.5	V
I _{DD}	Operating Current	5V	Functions enabled	—	—	2	mA
		2.5V	No load	—	—	0.8	mA
I _{STB}	Standby Current	2.5V	Functions disabled or $\overline{EN}=1$	—	—	1	μA
G _{DV}	Detection Level	5V	f _{IN} =305~640Hz	-36	—	0	dBm
		2.5V	ENV=1	-42	—	-8	dBm
G _{RL}	Rejection Level	—	All frequency, ENV=0	—	—	-50	dBm
f _{RL}	Rejection Out-band Frequency	—	V _{SIN} ≤ -50dBm, ENV=0	—	—	200	Hz
f _{RH}				800	—	—	Hz
t _{QI}	Detection Pause Time	—	V _{SIN} ≤ -50dBm, ENV=0	40	—	—	ms
t _{DD}	Detection Signal Time	—	In-band signal input, ENV=1	40	—	—	ms
t _B	Rejection Pause Time	—	V _{SIN} ≤ -50dBm, ENV=1	—	—	20	ms
t _{DH}	Envelope Output Delay Time	—	Time for high output	—	40	—	ms
t _{DL}		—	Time for low output	—	40	—	ms
t _{RD}	Rejection Noise Time	—	V _{SIN} =Any signal, ENV=0	—	—	20	ms
t _{ST}	Oscillator Start-up Time	—	—	—	0.8	2	sec
Z _I	Input Impedance	—	f _{IN} =200~3.4kHz	1.0	—	—	MΩ
V _{REF}	Reference Voltage	—	No load	2.4	2.5	2.6	V
Z _{REF}	Output Impedance	—	—	—	10	20	MΩ
V _{IH}	Logic Input High Voltage	5V	—	3.5	—	—	V
V _{IL}	Logic Input Low Voltage	5V	—	—	—	1.5	V
I _{IH}	Logic Input High Current	5V	V _{IH} =0.5V	—	—	0.1	μA
I _{IL}	Logic Input Low Current	5V	V _{IL} =0V	-0.1	—	—	μA
I _{OH}	Output High Current	5V	V _{OH} =4.5V	—	—	-0.5	mA
I _{OL}	Output Low Current	5V	V _{OL} =0.5V	2.0	—	—	mA
I _{SO}	Pull-down Current	5V	—	—	25	35	μA

Functional Description

The HT9020B call progress tone detector can be used in world wide countries. Below is an illustration of a call progress tone frequency band, and a table of U.S.A. CPT signal is shown for user reference. Usually, HT9020B must work together with a microcontroller through software to distinguish correct cadence of CPT to fit any country CPT SPEC requirement for world wide application purposes.

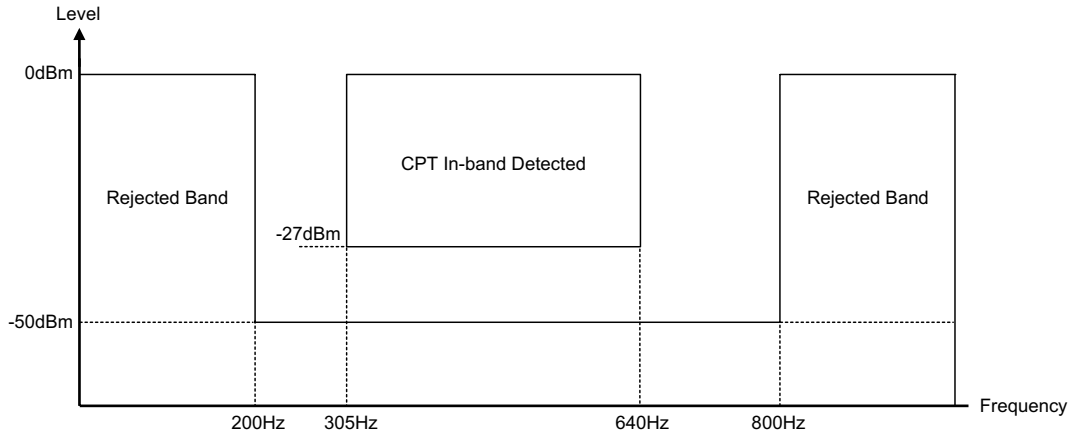

Call progress tone frequency band illustration

U.S.A. Call Progress Tone Signal Format

Tone	Frequency	Condition
Precision Dial Tone	350Hz+440Hz	Continuous high
Old Dial Tone	120Hz (or 133Hz, ...) +600Hz	Continuous high
Precision Busy Tone	480Hz+620Hz	0.5sec high and 0.5sec low
Old Busy Tone	120Hz+600Hz	0.5sec high and 0.5sec low
Precision Reorder Tone	480Hz+620Hz	0.3sec high and 0.2sec low
Old Reorder Tone	120Hz+600Hz	0.2sec high and 0.3sec low or 0.25sec high and 0.25sec low
Precision Ring-back Tone	440Hz+480Hz	2sec high and 4sec low
Old Ring-back Tone	40Hz (or the others) +420Hz	2sec high and 4sec low

Timing Diagram

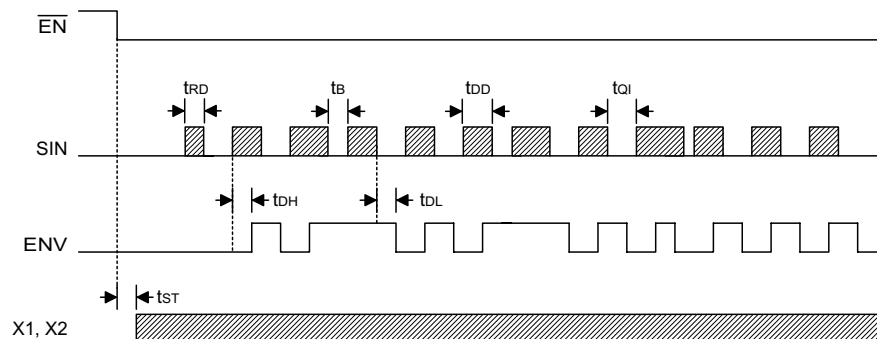

Application Circuits

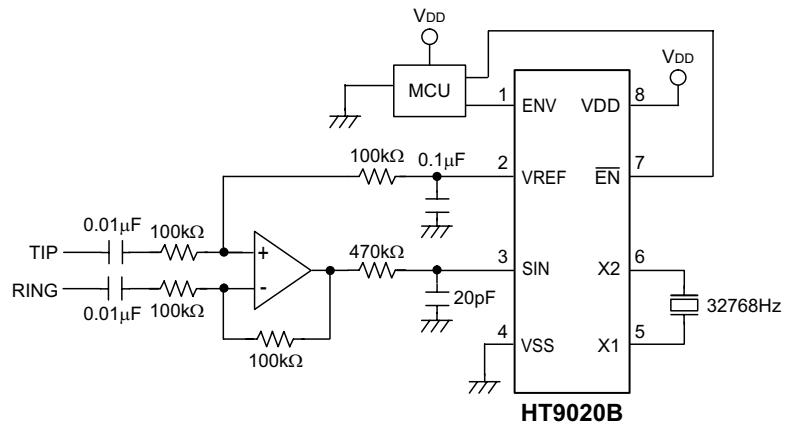

Package Information

8-pin DIP (300mil) Outline Dimensions

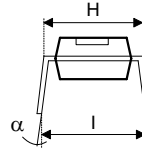
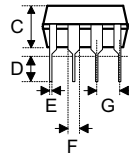
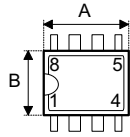

Symbol	Dimensions in mil		
	Min.	Nom.	Max.
A	355	—	375
B	240	—	260
C	125	—	135
D	125	—	145
E	16	—	20
F	50	—	70
G	—	100	—
H	295	—	315
I	335	—	375
α	0°	—	15°

Holtek Semiconductor Inc. (Headquarters)

No.3, Creation Rd. II, Science Park, Hsinchu, Taiwan
Tel: 886-3-563-1999
Fax: 886-3-563-1189
<http://www.holtek.com.tw>

Holtek Semiconductor Inc. (Taipei Sales Office)

4F-2, No. 3-2, YuanQu St., Nankang Software Park, Taipei 115, Taiwan
Tel: 886-2-2655-7070
Fax: 886-2-2655-7373
Fax: 886-2-2655-7383 (International sales hotline)

Holtek Semiconductor Inc. (Shanghai Sales Office)

7th Floor, Building 2, No.889, Yi Shan Rd., Shanghai, China 200233
Tel: 021-6485-5560
Fax: 021-6485-0313
<http://www.holtek.com.cn>

Holtek Semiconductor Inc. (Shenzhen Sales Office)

43F, SEG Plaza, Shen Nan Zhong Road, Shenzhen, China 518031
Tel: 0755-8346-5589
Fax: 0755-8346-5590
ISDN: 0755-8346-5591

Holtek Semiconductor Inc. (Beijing Sales Office)

Suite 1721, Jinyu Tower, A129 West Xuan Wu Men Street, Xicheng District, Beijing, China 100031
Tel: 010-6641-0030, 6641-7751, 6641-7752
Fax: 010-6641-0125

Holmate Semiconductor, Inc. (North America Sales Office)

46712 Fremont Blvd., Fremont, CA 94538
Tel: 510-252-9880
Fax: 510-252-9885
<http://www.holmate.com>

Copyright © 2003 by HOLTEK SEMICONDUCTOR INC.

The information appearing in this Data Sheet is believed to be accurate at the time of publication. However, Holtek assumes no responsibility arising from the use of the specifications described. The applications mentioned herein are used solely for the purpose of illustration and Holtek makes no warranty or representation that such applications will be suitable without further modification, nor recommends the use of its products for application that may present a risk to human life due to malfunction or otherwise. Holtek's products are not authorized for use as critical components in life support devices or systems. Holtek reserves the right to alter its products without prior notification. For the most up-to-date information, please visit our web site at <http://www.holtek.com.tw>.