

DS14185 EIA/TIA-232 3 Driver x 5 Receiver

 Check for Samples: [DS14185](#)

FEATURES

- Replaces One 1488 and Two 1489s
- Conforms to EIA/TIA-232-E
- 3 Drivers and 5 Receivers
- Flow Through Pinout
- Failsafe Receiver Outputs
- 20-pin SOIC Package
- LapLink Compatible –200 kbps Data Rate

DESCRIPTION

The DS14185 is a three driver, five receiver device which conforms to the EIA/TIA-232-E standard.

The flow-through pinout facilitates simple non-crossover board layout. The DS14185 provides a one-chip solution for the common 9-pin serial RS-232 interface between data terminal and data communications equipment.

Connection Diagram

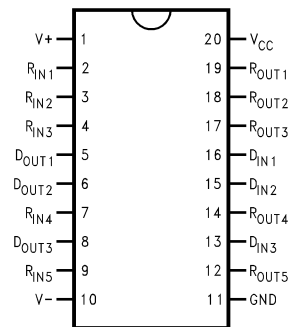

Figure 1. SOIC
See Package DW0020B

Functional Diagram

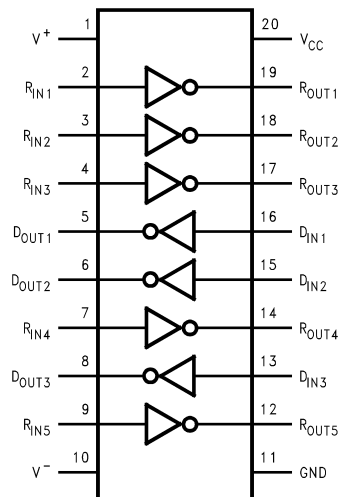

Figure 2.



Please be aware that an important notice concerning availability, standard warranty, and use in critical applications of Texas Instruments semiconductor products and disclaimers thereto appears at the end of this data sheet.

All trademarks are the property of their respective owners.



These devices have limited built-in ESD protection. The leads should be shorted together or the device placed in conductive foam during storage or handling to prevent electrostatic damage to the MOS gates.

Absolute Maximum Ratings⁽¹⁾⁽²⁾

Supply Voltage (V_{CC})		+7V
Supply Voltage (V^+)		+15V
Supply Voltage (V^-)		-15V
Driver Input Voltage		0V to V_{CC}
Driver Output ⁽³⁾ Voltage (Power Off)		± 15 V
Receiver Input Voltage		± 25 V
Receiver Output Voltage (R_{OUT})		0V to V_{CC}
Maximum Package Power Dissipation @ +25°C	DW Package	1488 mW
Derate DW Package		11.9 mW/°C above +25°C
Storage Temperature Range		-65°C to +150°C
Lead Temperature Range (Soldering, 4 seconds)		+260°C
ESD Ratings (HBM, 1.5 k Ω , 100 pF)		≥ 1.5 kV

- (1) Absolute Maximum Ratings are those values beyond which the safety of the device cannot be specified. They are not meant to imply that the devices should be operated at these limits. The table of Electrical Characteristics specifies conditions of device operation.
- (2) If Military/Aerospace specified devices are required, please contact the Texas Instruments Sales Office/ Distributors for availability and specifications.
- (3) Only one driver output shorted at a time.

Recommended Operating Conditions

	Min	Typ	Max	Units
Supply Voltage (V_{CC})	+4.75	+5.0	+5.25	V
Supply Voltage (V^+)	+9.0	+12.0	+13.2	V
Supply Voltage (V^-)	-13.2	-12.0	-9.0	V
Operating Free Air Temperature (T_A)	0	25	70	°C

Electrical Characteristics⁽¹⁾

Over recommended supply voltage and operating temperature ranges, unless otherwise specified.

Symbol	Parameter	Conditions	Min	Typ ⁽²⁾	Max	Units
DEVICE CHARACTERISTICS						
I_{CC}	V_{CC} Supply Current	No Load, All Inputs at +5V		21.0	30	mA
I^+	V^+ Supply Current ⁽¹⁾	No Load, All Driver Inputs at 0.8V or +2V All Receiver Inputs at 0.8V or 2.4V.		8.7	15	mA
			$V^+ = 9V, V^- = -9V$		13	22
I^-	V^- Supply Current ⁽¹⁾			-12.5	-22	mA
			$V^+ = 13.2V, V^- = -13.2V$		-16.5	-28

- (1) Current into device pins is defined as positive. Current out of device pins is defined as negative. All voltages are referenced to ground unless otherwise specified. For current, minimum and maximum values are specified as an absolute value and the sign is used to indicate direction. For voltage logic levels, the more positive value is designated as maximum. For example, if -6V is a maximum, the typical value (-6.8V) is more negative.
- (2) All typicals are given for: $V_{CC} = +5.0V, V^+ = +12.0V, V^- = -12V, T_A = +25^\circ C$.

Electrical Characteristics⁽¹⁾ (continued)

Over recommended supply voltage and operating temperature ranges, unless otherwise specified.

Symbol	Parameter	Conditions	Min	Typ ⁽²⁾	Max	Units
DRIVER CHARACTERISTICS						
V _{IH}	High Level Input Voltage		2.0			V
V _{IL}	Low Level Input Voltage				0.8	V
I _{IH}	High Level Input Current ⁽³⁾	V _{IN} = 5V			10	μA
I _{IL}	Low Level Input Current ⁽³⁾	V _{IN} = 0V		-1.24	-1.5	mA
V _{OH}	High Level Output Voltage ⁽³⁾	R _L = 3 kΩ, V _{IN} = 0.8V, V ⁺ = 9V, V ⁻ = -9V	6	7		V
		R _L = 3 kΩ, V _{IN} = 0.8V, V ⁺ = +12V, V ⁻ = -12V	8.5	9		V
		R _L = 7 kΩ, V _{IN} = 0.8V, V ⁺ = +13.2V, V ⁻ = -13.2V	10	11.5		V
V _{OL}	Low Level Output Voltage ⁽³⁾	R _L = 3 kΩ, V _{IN} = 2V, V ⁺ = 9V, V ⁻ = -9V		-7	-6	V
		R _L = 3 kΩ, V _{IN} = 2V, V ⁺ = +12V, V ⁻ = -12V		-8	-7.5	V
		R _L = 7 kΩ, V _{IN} = 0.8V, V ⁺ = +13.2V, V ⁻ = -13.2V		-11	-10	V
I _{OS+}	Output High Short Circuit Current ⁽³⁾	V _O = 0V, V _{IN} = 0.8V	-6	-13	-18	mA
I _{OS-}	Output Low Short Circuit Current ⁽³⁾	V _O = 0V, V _{IN} = 2.0V	6	13	18	mA
R _O	Output Resistance	-2V ≤ V _O ≤ +2V, V ⁺ = V ⁻ = V _{CC} = 0V	300			Ω
		-2V ≤ V _O ≤ +2V, V ⁺ = V ⁻ = V _{CC} = Open Ckt	300			Ω
RECEIVER CHARACTERISTICS						
V _{TH}	Input High Threshold (Recognized as a High Signal)	V _O ≤ 0.4V, I _O = 3.2 mA		1.85	2.4	V
V _{TL}	Input Low Threshold (Recognized as a Low Signal)	V _O ≥ 2.5V, I _O = -0.5 mA	0.7	1.0		V
R _{IN}	Input Resistance	V _{IN} = ±3V to ±15V	3.0	4.1	7.0	kΩ
I _{IN}	Input Current ⁽³⁾	V _{IN} = +15V	2.1	4.1	5.0	mA
		V _{IN} = +3V	0.43	0.7	1	mA
		V _{IN} = -15V	-5.0	-4.1	-2.1	mA
		V _{IN} = -3V	-1	-0.65	-0.43	mA
V _{OH}	High Level Output Voltage ⁽⁴⁾	I _{OH} = -0.5 mA, V _{IN} = -3V	2.6	4		V
		I _{OH} = -10 μA, V _{IN} = -3V	4.0	4.9		V
		I _{OH} = -0.5 mA, V _{IN} = Open Circuit	2.6	4		V
		I _{OH} = -10 μA, V _{IN} = Open Circuit	4.0	4.9		V
V _{OL}	Low Level Output Voltage	I _{OL} = 3.2 mA, V _{IN} = +3V		0.2	0.4	V
I _{OSR}	Short Circuit Current ⁽³⁾	V _O = 0V, V _{IN} = 0V	-4	-2.7	-1.7	mA

(3) Current into device pins is defined as positive. Current out of device pins is defined as negative. All voltages are referenced to ground unless otherwise specified. For current, minimum and maximum values are specified as an absolute value and the sign is used to indicate direction. For voltage logic levels, the more positive value is designated as maximum. For example, if -6V is a maximum, the typical value (-6.8V) is more negative.

(4) If receiver inputs are unconnected, receiver output is a logic high.

Switching Characteristics⁽¹⁾

T_A = 25°C

Symbol	Parameter	Conditions	Min	Typ ⁽²⁾	Max	Units
DRIVER CHARACTERISTICS						
t _{PHL}	Propagation Delay High to Low	R _L = 3 kΩ, C _L = 50 pF (Figure 3 Figure 4)		60	350	ns
t _{PLH}	Propagation Delay Low to High			240	350	ns
t _r , t _f	Output Slew Rate ⁽³⁾			50		ns
RECEIVER CHARACTERISTICS						
t _{PHL}	Propagation Delay High to Low	R _L = 1.5 kΩ, C _L = 15 pF (includes fixture plus probe), (Figure 5 Figure 6)		150	350	ns
t _{PLH}	Propagation Delay Low to High			240	350	ns
t _r	Rise Time			87	175	ns
t _f	Fall Time			40	100	ns

- (1) Current into device pins is defined as positive. Current out of device pins is defined as negative. All voltages are referenced to ground unless otherwise specified. For current, minimum and maximum values are specified as an absolute value and the sign is used to indicate direction. For voltage logic levels, the more positive value is designated as maximum. For example, if -6V is a maximum, the typical value (-6.8V) is more negative.
- (2) All typicals are given for: V_{CC} = +5.0V, V⁺ = +12.0V, V⁻ = -12V, T_A = +25°C.
- (3) Refer to typical curves. Driver output slew rate is measured from the +3.0V to the -3.0V level on the output waveform. Inputs not under test are connected to V_{CC} or GND. Slew rate is determined by load capacitance. To comply with a 30 V/μs maximum slew rate, a minimum load capacitance of 390 pF is recommended.

Parameter Measurement Information

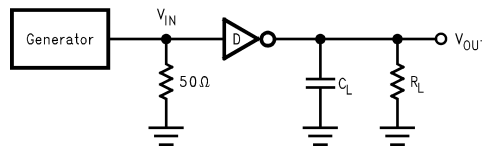

Generator characteristics for driver input: f = 64 kHz (128 kbits/sec), t_r = t_f < 10 ns, V_{IH} = 3V, V_{IL} = 0V, duty cycle = 50%.

Figure 3. Driver Propagation Delay and Transition Time Test Circuit

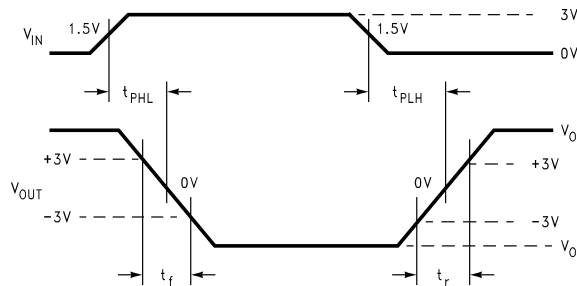
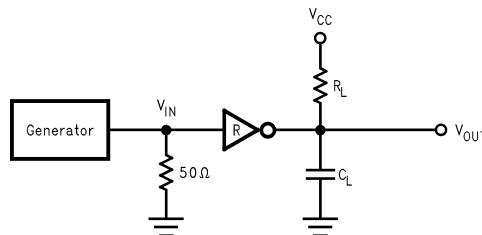
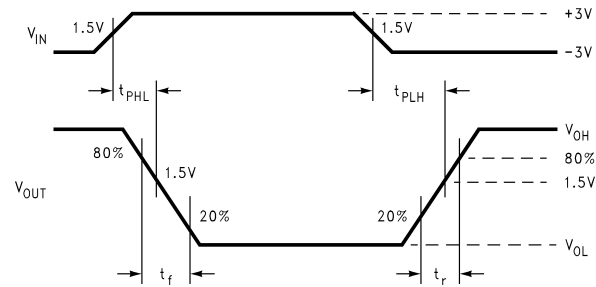

Figure 4. Driver Propagation Delay and Transition Time Waveforms Slew Rate (SR) = 6V/(t_r or t_f)



Generator characteristics for receiver input: f = 64 kHz (128 kbits/sec), t_r = t_f = 200 ns, V_{IH} = 3V, V_{IL} = -3V, duty cycle = 50%.

Figure 5. Receiver Propagation Delay and Transition Time Test Circuit

Figure 6. Receiver Propagation Delay and Transition Time Waveform
PIN DESCRIPTIONS

Pin #	Name	Description
13, 15, 16	D _{IN}	Driver Input Pins
5, 6, 8	D _{OUT}	Driver Output Pins, RS-232 Levels
2, 3, 4, 7, 9	R _{IN}	Receiver Input Pins, RS-232 Levels
12, 14, 17, 18, 19	R _{OUT}	Receiver Output Pins
11	GND	Ground
1	V ⁺	Positive Power Supply Pin (+9.0 ≤ V ⁺ ≤ +13.2)
10	V ⁻	Negative Power Supply Pin (-9.0 ≤ V ⁻ ≤ -13.2)
20	V _{CC}	Positive Power Supply Pin (+5V ±5%)

APPLICATIONS INFORMATION

In a typical Data Terminal Equipment (DTE) to Data Circuit-Terminating Equipment (DCE) 9-pin de-facto interface implementation, 2 data lines and 6 control lines are required. The data lines are TXD and RXD. The control lines are RTS, DTR, DSR, DCD, CTS, and RI.

The DS14185 is a 3 x 5 Driver/Receiver and offers a single chip solution for this DTE interface. As shown in [Figure 7](#), this interface allows for direct flow-thru interconnect. For a more conservative design, the user may wish to insert ground traces between the signal lines to minimize cross talk.

LapLink COMPATIBILITY

The DS14185 can easily provide 128 kbps data rate under maximum driver load conditions of $C_L = 2500$ pF and $R_L = 3$ k Ω , while power supplies are:

$$V_{CC} = 4.75V, V^+ = 10.8V, V^- = -10.8V \tag{1}$$

MOUSE DRIVING

A typical mouse can be powered from the drivers. Two driver outputs connected in parallel and set to V_{OH} can be used to supply power to the V^+ pin of the mouse. The third driver output is set to V_{OL} to sink the current from the V^- terminal. Refer to typical curves of V_{OUT}/I_{OUT} . Typical mouse specifications are:

$$10 \text{ mA at } +6V \tag{2}$$

$$5 \text{ mA at } -6V \tag{3}$$

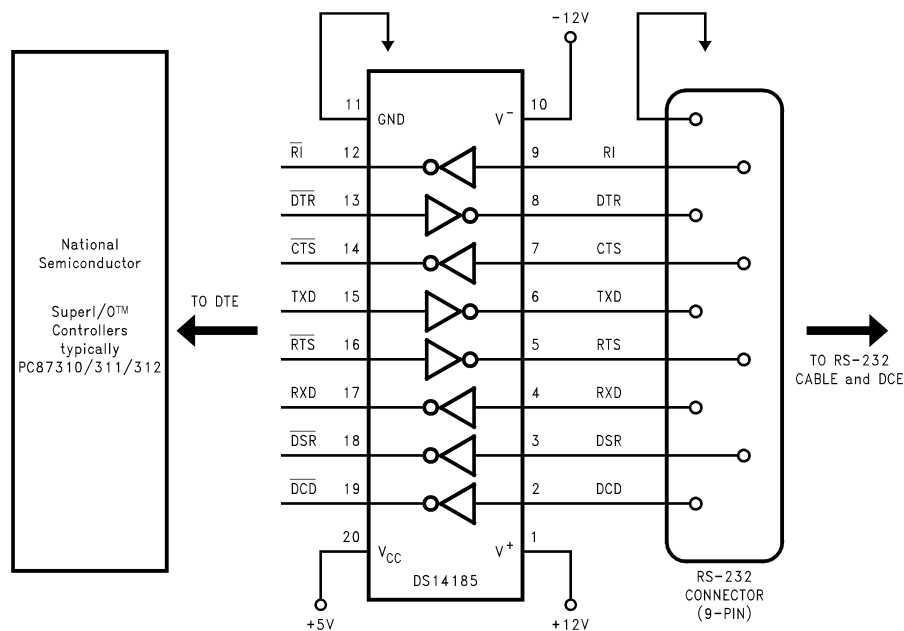

Figure 7. Typical DTE Application

Typical Performance Characteristics

The below input waveforms were used to generate all Typical AC Characteristics.

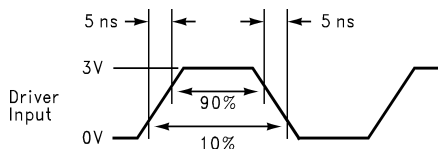

Figure 8.

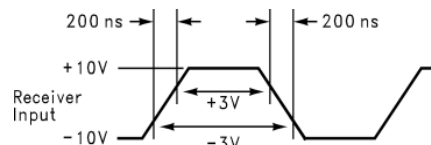

Figure 9.

Driver Output Slew Rate between +3V and -3V vs Load Capacitance
 Conditions: $V_{CC} = 5V$, $R_L = 5k\Omega$, $T_A = 25^\circ C$, $f_{IN} = 64$ kHz Square Wave

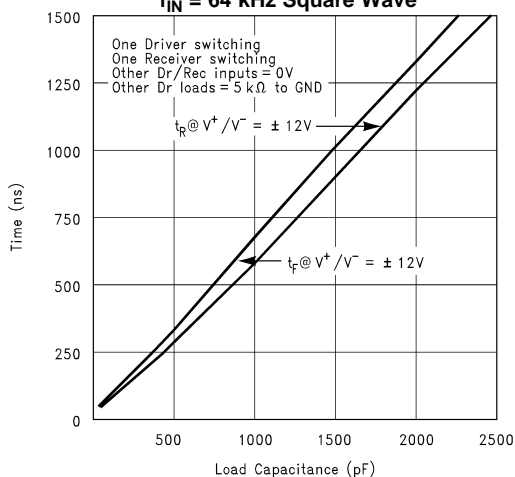

Figure 10.

Driver Output Voltage vs Frequency and C_L
 Conditions: $V_{CC} = 5V$, $R_L = 5k\Omega$, $T_A = 25^\circ C$

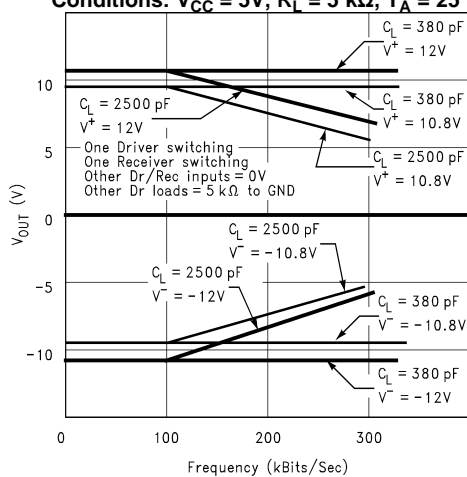

Figure 11.

Supply Current vs Frequency and Driver C_L

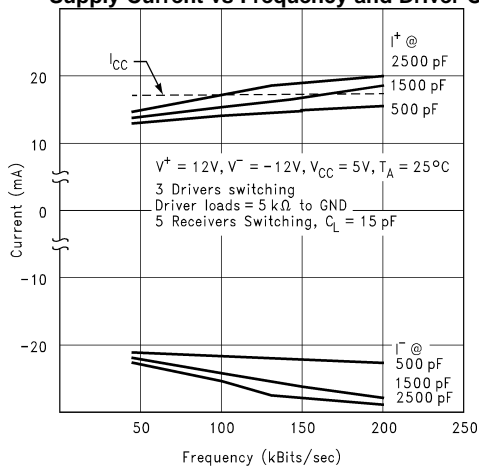

Figure 12.

Supply Current vs Frequency and Driver C_L

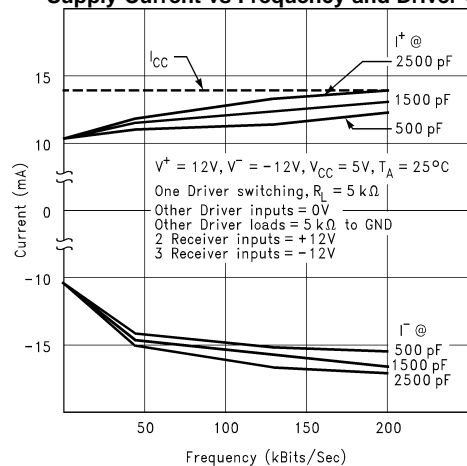

Figure 13.

Typical Performance Characteristics (continued)

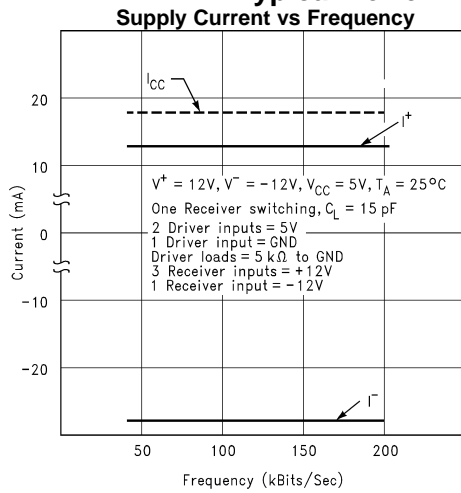

Figure 14.

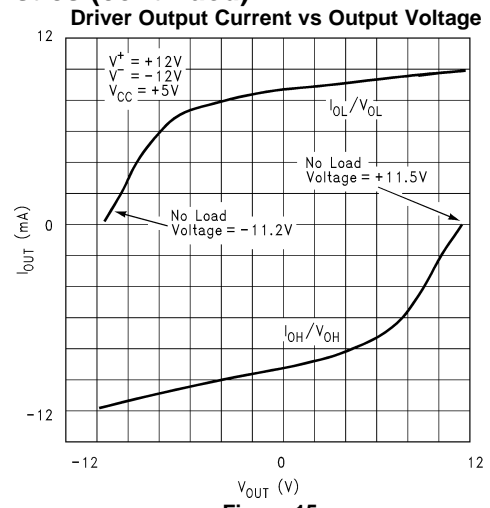

Figure 15.

REVISION HISTORY

Changes from Revision B (April 2013) to Revision C	Page
• Changed layout of National Data Sheet to TI format	8

PACKAGING INFORMATION

Orderable Device	Status (1)	Package Type	Package Drawing	Pins	Package Qty	Eco Plan (2)	Lead/Ball Finish (6)	MSL Peak Temp (3)	Op Temp (°C)	Device Marking (4/5)	Samples
DS14185WM	NRND	SOIC	DW	20	36	TBD	Call TI	Call TI	0 to 70	DS14185WM	
DS14185WM/NOPB	ACTIVE	SOIC	DW	20	36	Green (RoHS & no Sb/Br)	SN CU SN	Level-3-260C-168 HR	0 to 70	DS14185WM	Samples
DS14185WMX	NRND	SOIC	DW	20	1000	TBD	Call TI	Call TI	0 to 70	DS14185WM	
DS14185WMX/NOPB	ACTIVE	SOIC	DW	20	1000	Green (RoHS & no Sb/Br)	SN CU SN	Level-3-260C-168 HR	0 to 70	DS14185WM	Samples

(1) The marketing status values are defined as follows:

ACTIVE: Product device recommended for new designs.

LIFEBUY: TI has announced that the device will be discontinued, and a lifetime-buy period is in effect.

NRND: Not recommended for new designs. Device is in production to support existing customers, but TI does not recommend using this part in a new design.

PREVIEW: Device has been announced but is not in production. Samples may or may not be available.

OBSELETE: TI has discontinued the production of the device.

(2) Eco Plan - The planned eco-friendly classification: Pb-Free (RoHS), Pb-Free (RoHS Exempt), or Green (RoHS & no Sb/Br) - please check <http://www.ti.com/productcontent> for the latest availability information and additional product content details.

TBD: The Pb-Free/Green conversion plan has not been defined.

Pb-Free (RoHS): TI's terms "Lead-Free" or "Pb-Free" mean semiconductor products that are compatible with the current RoHS requirements for all 6 substances, including the requirement that lead not exceed 0.1% by weight in homogeneous materials. Where designed to be soldered at high temperatures, TI Pb-Free products are suitable for use in specified lead-free processes.

Pb-Free (RoHS Exempt): This component has a RoHS exemption for either 1) lead-based flip-chip solder bumps used between the die and package, or 2) lead-based die adhesive used between the die and leadframe. The component is otherwise considered Pb-Free (RoHS compatible) as defined above.

Green (RoHS & no Sb/Br): TI defines "Green" to mean Pb-Free (RoHS compatible), and free of Bromine (Br) and Antimony (Sb) based flame retardants (Br or Sb do not exceed 0.1% by weight in homogeneous material)

(3) MSL, Peak Temp. - The Moisture Sensitivity Level rating according to the JEDEC industry standard classifications, and peak solder temperature.

(4) There may be additional marking, which relates to the logo, the lot trace code information, or the environmental category on the device.

(5) Multiple Device Markings will be inside parentheses. Only one Device Marking contained in parentheses and separated by a "~" will appear on a device. If a line is indented then it is a continuation of the previous line and the two combined represent the entire Device Marking for that device.

(6) Lead/Ball Finish - Orderable Devices may have multiple material finish options. Finish options are separated by a vertical ruled line. Lead/Ball Finish values may wrap to two lines if the finish value exceeds the maximum column width.

Important Information and Disclaimer: The information provided on this page represents TI's knowledge and belief as of the date that it is provided. TI bases its knowledge and belief on information provided by third parties, and makes no representation or warranty as to the accuracy of such information. Efforts are underway to better integrate information from third parties. TI has taken and

continues to take reasonable steps to provide representative and accurate information but may not have conducted destructive testing or chemical analysis on incoming materials and chemicals. TI and TI suppliers consider certain information to be proprietary, and thus CAS numbers and other limited information may not be available for release.

In no event shall TI's liability arising out of such information exceed the total purchase price of the TI part(s) at issue in this document sold by TI to Customer on an annual basis.

TAPE AND REEL INFORMATION

QUADRANT ASSIGNMENTS FOR PIN 1 ORIENTATION IN TAPE

*All dimensions are nominal

Device	Package Type	Package Drawing	Pins	SPQ	Reel Diameter (mm)	Reel Width W1 (mm)	A0 (mm)	B0 (mm)	K0 (mm)	P1 (mm)	W (mm)	Pin1 Quadrant
DS14185WMX	SOIC	DW	20	1000	330.0	24.4	10.9	13.3	3.25	12.0	24.0	Q1
DS14185WMX/NOPB	SOIC	DW	20	1000	330.0	24.4	10.9	13.3	3.25	12.0	24.0	Q1

TAPE AND REEL BOX DIMENSIONS

*All dimensions are nominal

Device	Package Type	Package Drawing	Pins	SPQ	Length (mm)	Width (mm)	Height (mm)
DS14185WMX	SOIC	DW	20	1000	367.0	367.0	45.0
DS14185WMX/NOPB	SOIC	DW	20	1000	367.0	367.0	45.0

DW (R-PDSO-G20)

PLASTIC SMALL OUTLINE



- NOTES:
- A. All linear dimensions are in inches (millimeters). Dimensioning and tolerancing per ASME Y14.5M-1994.
 - B. This drawing is subject to change without notice.
 - C. Body dimensions do not include mold flash or protrusion not to exceed 0.006 (0,15).
 - D. Falls within JEDEC MS-013 variation AC.

IMPORTANT NOTICE

Texas Instruments Incorporated and its subsidiaries (TI) reserve the right to make corrections, enhancements, improvements and other changes to its semiconductor products and services per JESD46, latest issue, and to discontinue any product or service per JESD48, latest issue. Buyers should obtain the latest relevant information before placing orders and should verify that such information is current and complete. All semiconductor products (also referred to herein as "components") are sold subject to TI's terms and conditions of sale supplied at the time of order acknowledgment.

TI warrants performance of its components to the specifications applicable at the time of sale, in accordance with the warranty in TI's terms and conditions of sale of semiconductor products. Testing and other quality control techniques are used to the extent TI deems necessary to support this warranty. Except where mandated by applicable law, testing of all parameters of each component is not necessarily performed.

TI assumes no liability for applications assistance or the design of Buyers' products. Buyers are responsible for their products and applications using TI components. To minimize the risks associated with Buyers' products and applications, Buyers should provide adequate design and operating safeguards.

TI does not warrant or represent that any license, either express or implied, is granted under any patent right, copyright, mask work right, or other intellectual property right relating to any combination, machine, or process in which TI components or services are used. Information published by TI regarding third-party products or services does not constitute a license to use such products or services or a warranty or endorsement thereof. Use of such information may require a license from a third party under the patents or other intellectual property of the third party, or a license from TI under the patents or other intellectual property of TI.

Reproduction of significant portions of TI information in TI data books or data sheets is permissible only if reproduction is without alteration and is accompanied by all associated warranties, conditions, limitations, and notices. TI is not responsible or liable for such altered documentation. Information of third parties may be subject to additional restrictions.

Resale of TI components or services with statements different from or beyond the parameters stated by TI for that component or service voids all express and any implied warranties for the associated TI component or service and is an unfair and deceptive business practice. TI is not responsible or liable for any such statements.

Buyer acknowledges and agrees that it is solely responsible for compliance with all legal, regulatory and safety-related requirements concerning its products, and any use of TI components in its applications, notwithstanding any applications-related information or support that may be provided by TI. Buyer represents and agrees that it has all the necessary expertise to create and implement safeguards which anticipate dangerous consequences of failures, monitor failures and their consequences, lessen the likelihood of failures that might cause harm and take appropriate remedial actions. Buyer will fully indemnify TI and its representatives against any damages arising out of the use of any TI components in safety-critical applications.

In some cases, TI components may be promoted specifically to facilitate safety-related applications. With such components, TI's goal is to help enable customers to design and create their own end-product solutions that meet applicable functional safety standards and requirements. Nonetheless, such components are subject to these terms.

No TI components are authorized for use in FDA Class III (or similar life-critical medical equipment) unless authorized officers of the parties have executed a special agreement specifically governing such use.

Only those TI components which TI has specifically designated as military grade or "enhanced plastic" are designed and intended for use in military/aerospace applications or environments. Buyer acknowledges and agrees that any military or aerospace use of TI components which have **not** been so designated is solely at the Buyer's risk, and that Buyer is solely responsible for compliance with all legal and regulatory requirements in connection with such use.

TI has specifically designated certain components as meeting ISO/TS16949 requirements, mainly for automotive use. In any case of use of non-designated products, TI will not be responsible for any failure to meet ISO/TS16949.

Products

Audio	www.ti.com/audio
Amplifiers	amplifier.ti.com
Data Converters	dataconverter.ti.com
DLP® Products	www.dlp.com
DSP	dsp.ti.com
Clocks and Timers	www.ti.com/clocks
Interface	interface.ti.com
Logic	logic.ti.com
Power Mgmt	power.ti.com
Microcontrollers	microcontroller.ti.com
RFID	www.ti-rfid.com
OMAP Applications Processors	www.ti.com/omap
Wireless Connectivity	www.ti.com/wirelessconnectivity

Applications

Automotive and Transportation	www.ti.com/automotive
Communications and Telecom	www.ti.com/communications
Computers and Peripherals	www.ti.com/computers
Consumer Electronics	www.ti.com/consumer-apps
Energy and Lighting	www.ti.com/energy
Industrial	www.ti.com/industrial
Medical	www.ti.com/medical
Security	www.ti.com/security
Space, Avionics and Defense	www.ti.com/space-avionics-defense
Video and Imaging	www.ti.com/video

TI E2E Community

e2e.ti.com