



A6A:30.XX

VOLTAGE RATINGS

Part Number	V_{RRM}, V_R (V) Max. rep. peak reverse voltage		V_{RSM}, V_R (V) Max. non- rep. peak reverse voltage
	$T_J = 0$ to 150°C	$T_J = -40$ to 0°C	$T_J = 25$ to 150°C
	A6A:30.01	100	100
A6A:30.02	200	200	300
A6A:30.04	400	400	500
A6A:30.06	600	600	700
A6A:30.08	800	800	900

This datasheet applies to:

A6A:30.XX, A6B:30.XX

For long lead, add "L"
to the end of part number

MAXIMUM ALLOWABLE RATINGS

PARAMETER	VALUE	UNITS	NOTES
T_J Junction Temperature	-40 to 150	$^\circ\text{C}$	-
T_{stg} Storage Temperature	-40 to 150	$^\circ\text{C}$	-
$I_{F(AV)}$ Max. Av. current @ Max. T_C	30	A	180° half sine wave
	150	$^\circ\text{C}$	
$I_{F(RMS)}$ Nom. RMS current	47	A	-
I_{FSM} Max. Peak non-rep. surge current	288	A	50 Hz half cycle sine wave Initial $T_J = 150^\circ\text{C}$, rated V_{RRM} applied after surge.
	314		60 Hz half cycle sine wave
	360		50 Hz half cycle sine wave Initial $T_J = 150^\circ\text{C}$, no voltage applied after surge.
	377		60 Hz half cycle sine wave
I^2t Max. I^2t capability	452	A^2s	$t = 10\text{ms}$ Initial $T_J = 150^\circ\text{C}$, rated V_{RRM} applied after surge.
	415		$t = 8.3\text{ms}$
	648		$t = 10\text{ms}$ Initial $T_J = 150^\circ\text{C}$, no voltage applied after surge.
	590		$t = 8.3\text{ms}$
$I^2t^{1/2}$ Max. $I^2t^{1/2}$ capability	9.165	$\text{A}^2\text{s}^{1/2}$	Initial $T_J = 150^\circ\text{C}$, no voltage applied after surge. I^2t for time $t_x = I^2t^{1/2} * t_x^{1/2}$. ($0.1 < t_x < 10\text{ms}$).



A6A:30.XX

CHARACTERISTICS

PARAMETER	MIN.	TYP.	MAX.	UNITS	TEST CONDITIONS
V _{FM} Peak forward voltage	---	---	1.30	V	Initial T _J = 25°C, sinusoidal wave, I _{peak} = 94A.
V _{F(TO)1} Low-level threshold	---	---	0.73	V	T _J = 180°C
V _{F(TO)2} High-level threshold	---	---	0.95		Av. power = V _{F(TO)} * I _{F(AV)} + r _F * [I _{F(RMS)}] ²
r _{F1} Low-level resistance	---	---	6.00	m	Use low values for I _{FM} < I _{F(AV)}
r _{F2} High-level resistance	---	---	3.00		
I _{RM} Peak reverse current	---	---	4.00	mA	T _J = 180 °C. Max. Rated V _{RRM}
R _{thJC} Thermal resistance, junction-to-case	---	---	1.14	°C/W	DC operation
R _{thCS} Thermal resistance, case-to-sink	---	---	0.55	°C/W	Mtg. Surface smooth, flat and greased. Single side.
wt Weight	---	10(0.36)	---	g(oz.)	---
Case Style	Press-fit		---	---	---

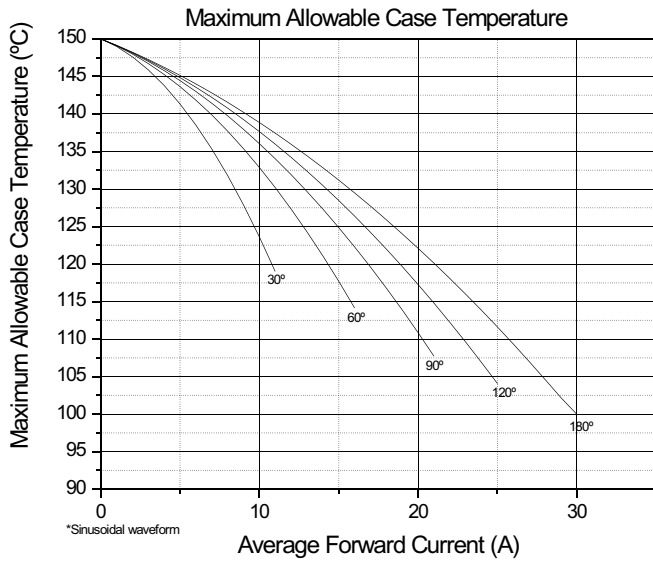

Fig. 1 - Current Ratings Characteristics

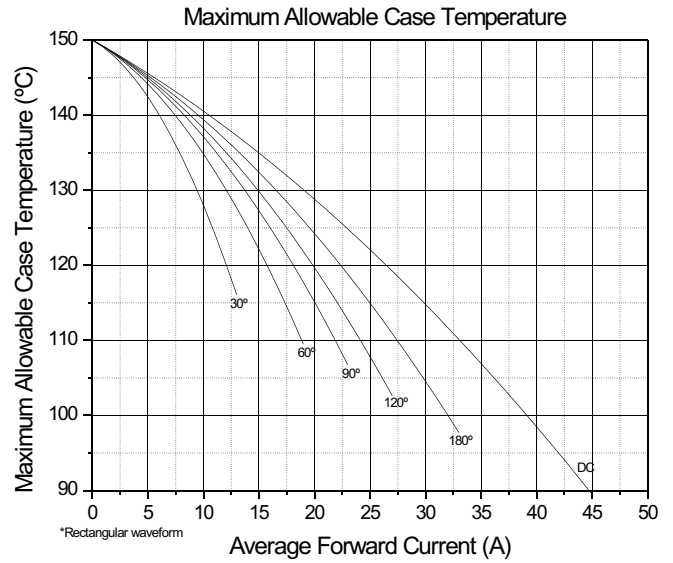

Fig. 2 - Current Ratings Characteristics



A6A:30.XX

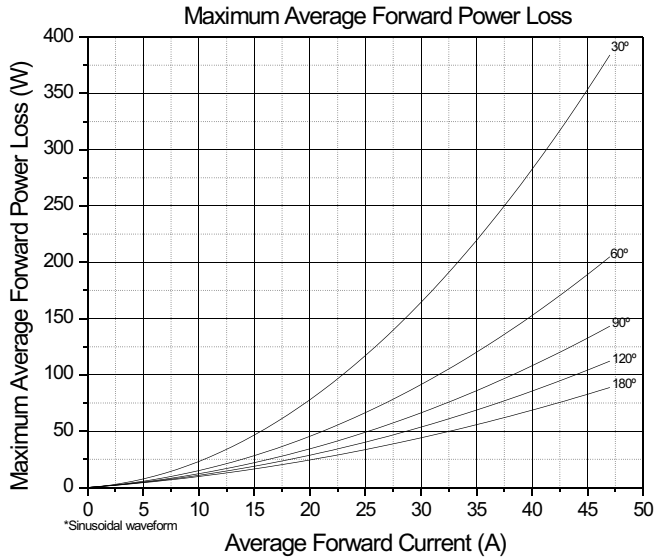

Fig. 3 - Average Forward Power Loss Characteristics

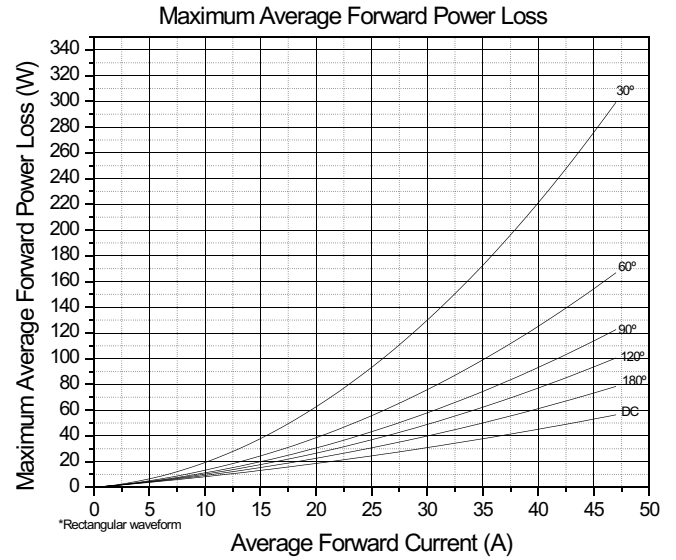

Fig. 4 - Average Forward Power Loss Characteristics

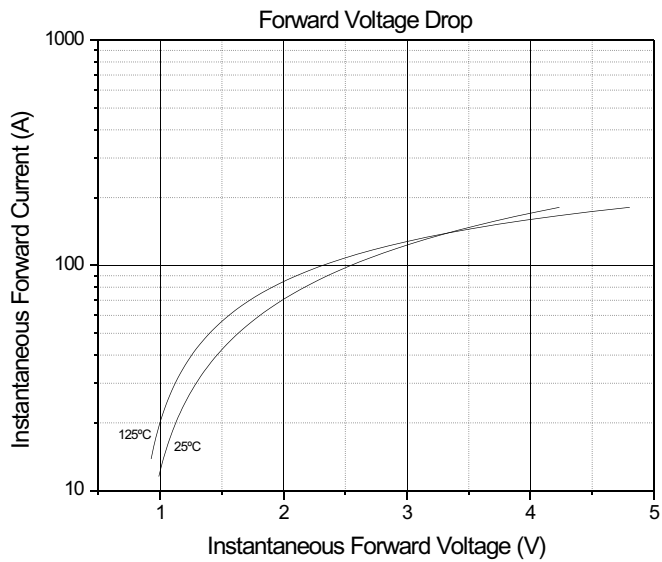

Fig. 5 - Forward Voltage Drop Characteristics

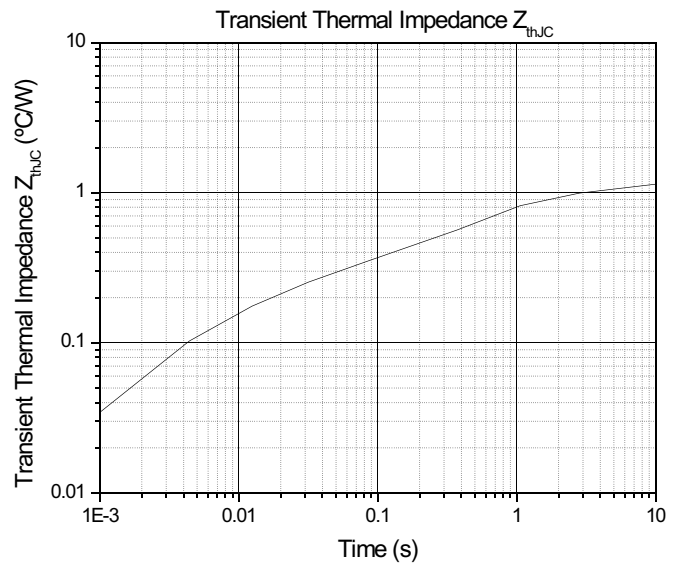

Fig. 6 - Transient Thermal Impedance Z_{thJC} Characteristics



A6A:30.XX

“Press-Fit”

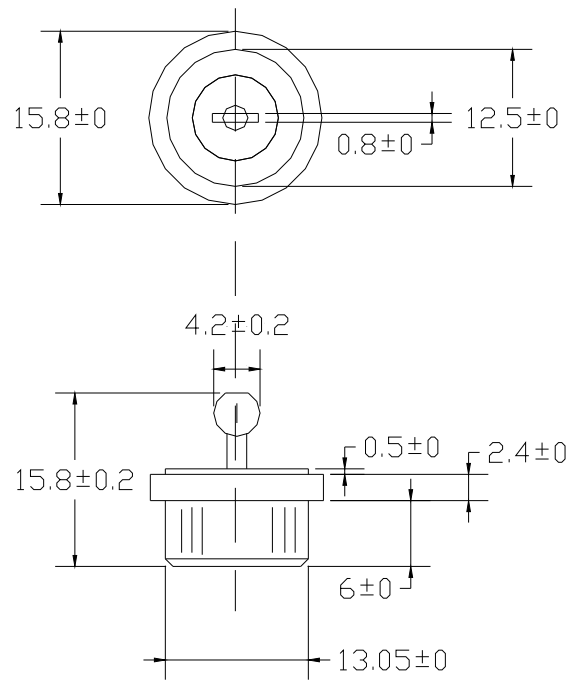

Fig. 7 - Outline Characteristics